

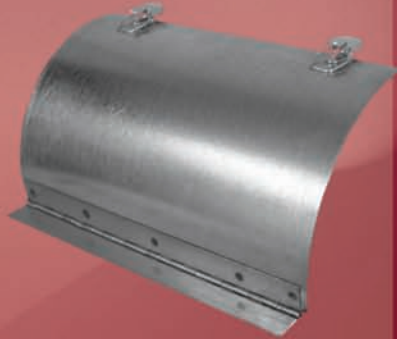

Access Door Products



Standard 2 Day Shipping





ADP offers standard 2-Day “Quick Ship” service on all the products you see in this catalog at no increase in price for the premium service. For those occasions when even faster shipping is needed we also offer Next Day “Quicker Ship” and Same Day “Quickest Ship” options on most of our products, as follows:

Shipping Options	Lead Time (working days)	Percentage Add	Order Cut-Off Time
Quick Ship orders	2 Days Max	No Add	5:00 pm (Pacific)
Quicker Ship orders	Next Day	15%	5:00 pm (Pacific)
Quickest Ship orders	Same Day	25%	2:00 pm (Pacific)

Straight Talk: While our on-time shipping performance has exceeded 95% for five years running, it is possible that a sudden increase in demand or an unexpected large order could impact our stock, thus our *Quick Ship* options are subject to availability. Please see the Limitations paragraph below for your options, should a shortage occur.

Terms & Conditions

Lead Time: For standard 2-Day *Quick Ship* orders, the lead time clock begins the day after you place your order. For example, if you place your order on a Monday, the next day, Tuesday, is Day 1. You can expect your order to ship no later than Day 2, which would be Wednesday if there are no holidays. Orders entered after 5:00 pm are considered to be entered the next business day.

Quicker and *Quickest Ship* orders work similarly. For example, a Next Day *Quicker Ship* order placed on a Monday will ship the next day, Tuesday. Same Day *Quickest Ship* orders must be placed before 2:00 pm Pacific Time to be shipped the same day. Same day local delivery may also be available on orders placed by 10:00 am. Please call for availability.

Pricing: All prices are list. Please refer to your current Discount Schedule for applicable multipliers. 2-Day shipping is standard (subject to availability). For all orders under \$350 net, a Small Order Freight Add of \$30 will apply.

Freight Terms: All orders are shipped F.O.B. Origin. Actual freight rates will be charged for 2nd Day, Next Day, and Courier shipments, as well as on all orders that do not qualify for Prepaid freight. Please refer to your current Discount Schedule for Freight Factors on orders shipping 500 miles or more from the 92154 zip code.

Limitations: While our goal is to ship orders in two days or less, with our accelerated shipping schedule some shortages may occur. As a result, our *Quick Ship* options are subject to availability. Should we encounter a shortage on a qualified freight Prepaid order we will contact you to determine if you wish the entire order to be held until the shortages arrive (so everything ships prepaid) or if we should ship what we have available. Backorders cannot be shipped prepaid. Any items you instruct us to backorder will ship Prepaid & Add.

Payment terms: 1% 10, Net 30 from the date of our invoice for customers with approved credit. A service charge of 1.5% per month will be charged and collected on all past due account balances. Credit card payment is also accepted at time of purchase only, no discount allowed. Accounts with balances over 45 days old will be on shipping hold.

Returns: Returns will not be accepted unless accompanied by a Return Goods Authorization (RGA) form issued by ADP. Return goods will be inspected upon receipt by ADP and for all products accepted for restocking, 75% of the purchase price (excluding outbound freight) will be refunded. Products which have been installed or damaged (including packaging) are not suitable for restocking and no credit will be given. All returns must be returned to their point of origin, freight prepaid. If requested, we will issue a call tag for items to be returned, in which case return freight charges will be deducted from any credit issued.

Minimum order: For all orders under \$350 net a Small Order Freight Add will apply.

Changes: All orders are subject to a \$10 change fee per line item changed. Upon receipt of a change order, the date the change order is received becomes the new order receipt date and the lead time clock starts anew. Changes can not be accepted on the day of shipment.

Cancellations: Because of our accelerated shipping commitment we begin work on your order immediately upon receipt. Therefore, all orders cancelled after placement or before shipment will be subject to a 15% cancellation charge.

Damage or Loss: Unless otherwise agreed, all shipments are made F.O.B. Origin. ADP will not be responsible for delays in delivery by carrier, for loss or damage to merchandise in transit, for reconignment fees or for storage fees due to delay in delivery. Where shortages or damages occur, details should be noted on the freight bill by the customer at time of delivery and reported to ADP within ten (10) days of shipment. In case of concealed damage, customer should call the carrier immediately to inspect damaged merchandise. With the exception of UPS and Fed-Ex ground shipments, all claims must be filed direct with the carrier by the customer. However, we will gladly assist our customer in attempting to secure prompt and satisfactory settlement.







Warranty: ADP warrants our products for a period of twelve (12) months from the date of shipment against defects in materials and workmanship. If a product fails to perform properly within this period, ADP will replace or repair it at our option. This warranty does not extend to and does not cover defects caused by misuse, abuse, accident, improper installation or alteration. This warranty is for materials only and specifically excludes labor for removal or installation, as well as any and all forms of indemnification.

Force Majeure: ADP shall not be liable for delays or defaults in delivery caused by floods, fires, storms or other acts of God, by war or act of public enemy or civil disturbance, strikes, lockouts, shortages of labor or raw materials and suppliers (including fuel) or production facilities, transportation service or equipment shortages or failures, actions or any governmental authority, or other conditions beyond our reasonable control.

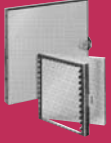
Sales: All sales are governed by the Terms and Conditions found on this page. If you do not accept these terms you must notify us within 24 hours of receiving our Acknowledgement. If you accept delivery of our goods, you will be deemed to have accepted these Terms of Sale in full. You further agree that these Terms of Sale supersede any additional or different terms or conditions contained in your purchase order or in any other agreement between you and ADP.

Air Distribution Products

9668 Heinrich Hertz Drive #D, San Diego, CA 92154 • Ph: (800) 322-8676 Fx: (800) 604-3324

	Classic Duct Access Doors Page 1		Flat Oval Duct Access Doors Page 5
	Low Leakage Sticktite Access Doors Page 2		Spiral Duct Access Doors Page 6
	Multi-Use Access Doors Page 3		Economy Duct Access Doors Page 7
	Fire Rated Access Doors Page 4		

ADSM Features:

- Door and frame are fabricated from galvanized steel
- Camlock closure is self tightening and hand operated
- Door is 1" thick, double wall construction and insulated
- Continuous piano type hinge
- Knock-over tabs

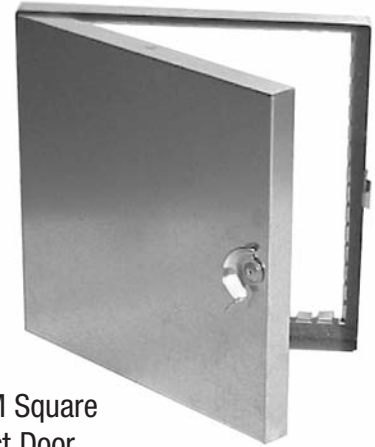

ADSM Square Duct Door

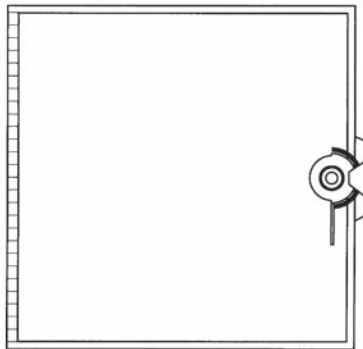

Front View

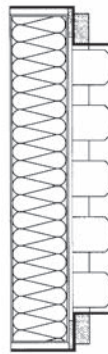

Section View

Damper Size	5020 List Price	SKU
6"x 6"	40	72111
8"x 8"	42	72112
10"x 10"	49	72113
12"x 12"	53	72114
14"x 14"	63	72115
16"x 16"	74	72116
18"x 18"	83	72117
24"x 24"	112	72118

ADSTI and ADSTE Features:

- Zero leakage to 4" S.P.
- Full-length hinge with camlock closure
- Double wall with 1" fiberglass insulation
- Pre-drilled screw holes and self-adhesive backed flange for fast installation



ADSTI

ADSTI Size	List Price	SKU
6"x 6"	40	41353
8"x 8"	50	41354
10"x 10"	57	41355
12"x 12"	62	41356
14"x 14"	78	41357
16"x 16"	95	41358
18"x 18"	107	41359
24"x 24"	152	41360

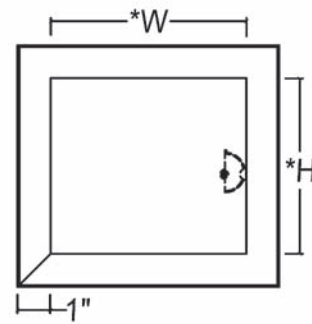

*W & H dim. = Actual Size (not undersized)

ADSTE Size	List Price	SKU
6"x 6"	40	41451
8"x 8"	50	41452
10"x 10"	57	41453
12"x 12"	62	41454
14"x 14"	78	41455
16"x 16"	95	41456
18"x 18"	107	41457
24"x 24"	152	41458

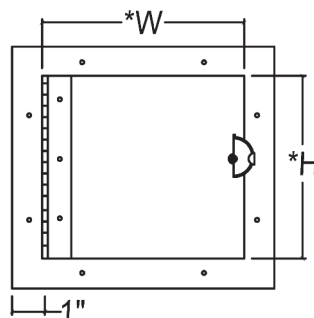
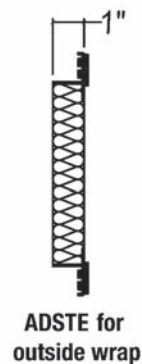

ADSTE

ADMU Features:

- For wallboard, plaster, wood or masonry surfaces
- 14 gauge, galvanized steel with primecoat finish
- Concealed, continuous piano hinge
- Screwdriver operated latch



ADMU Multi-Use Access Door

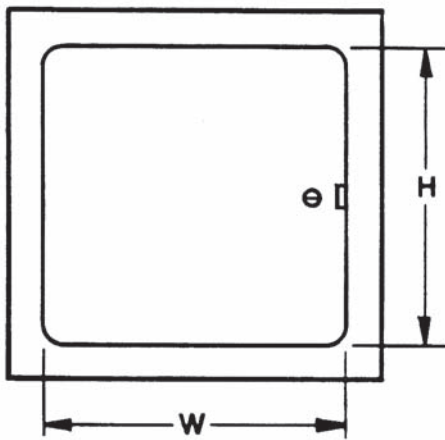

Front View

Square Size	List Price	SKU
8" x 8"	50	72103
10" x 10"	58	72104
12" x 12"	63	72105
14" x 14"	77	72106
16" x 16"	88	72107
18" x 18"	100	72108
20" x 20"	129	72109
24" x 24"	140	72110

ADFR Features:

- 1-1/2 hour fire rated
- UL Classified, File No. R-13067S
- California State Fire Marshall File No. 3330-1223: 100
- Warnock Hersey approved for ceiling applications



ADFR Fire Rated Door

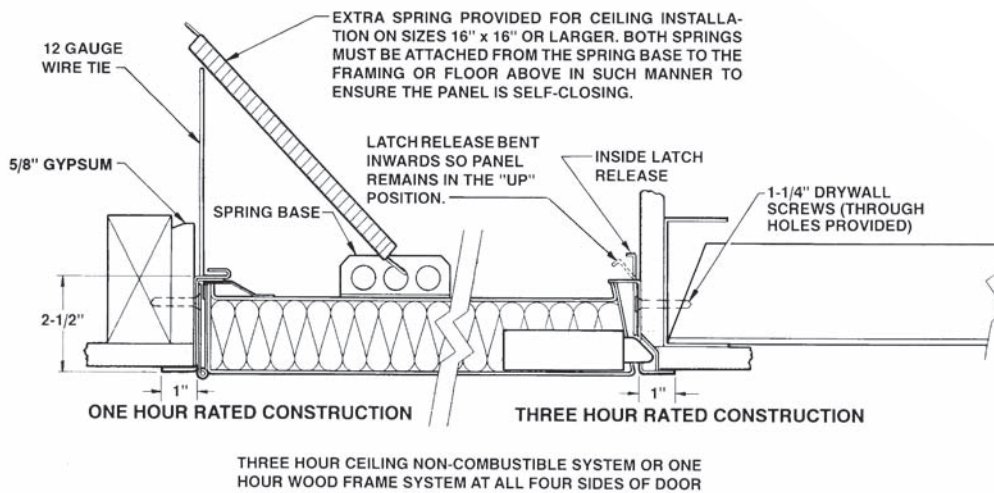

Square Size	List Price	SKU
12"x 12"	265	72100
14"x 14"	296	72101
24"x 24"	508	72102

ADSO Features:

- Easy install: Much faster than square doors
- Premium performance
- Ultra-low leakage
- Ergonomic sizing
- Insulated
- Knock-over tabs
- Safety chain



ADSO Flat Oval Duct Door

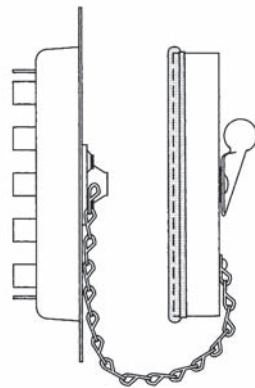

Section View

Oval Size	List Price	SKU
8"x 5"	40	72119
12"x 6"	50	72120
18"x 10"	86	72121
21"x 14"	139	72122
25"x 17"	194	72123

ADSD Features:

- Insulated doors for round duct
- Sandwich design
- Bolt & Knob fastening
- Quick installation

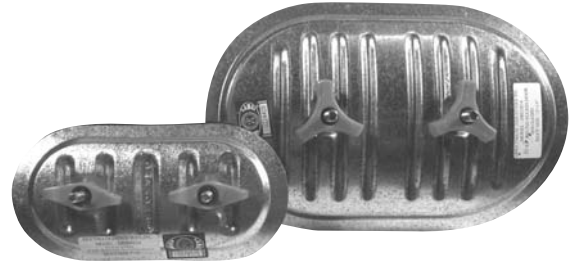

ADSD Spiral Duct Door

Oval Size	Spiral Size	List Price	SKU
8" x 4"	4" – 6"	118	12752
8" x 4"	7" – 8"	118	12753
8" x 4"	9" – 10"	118	12754
8" x 4"	12"	118	12755
8" x 4"	14"	118	12756
10" x 6"	9" – 10"	118	12757
10" x 6"	12"	135	12758
10" x 6"	14"	135	12759
10" x 6"	16"	135	12760
10" x 6"	18"	135	12761
10" x 6"	20"	135	12762

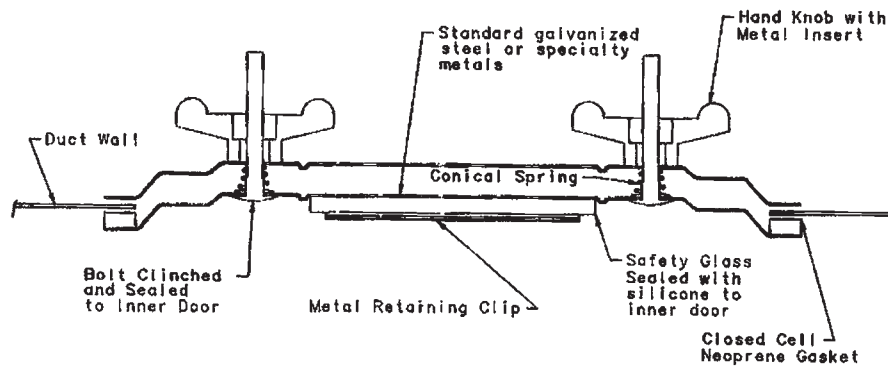

ADSE Features:

- 16 gauge galvanized steel
- Zinc plated hinge
- Strike and catch zinc plated steel
- Polyethylene gasket

ADSE



Hinged door installs easily onto low pressure round duct providing convenient access. Strike and catch style closure and factory installed gasket ensure positive seal.

Model	Duct Dia.	Dim. A	Dim. B	# of Hinges	List Price	SKU
ADSE 05	5"	7"	4"	2	79	41463
ADSE 06	6"	8"	5"	2	81	41464
ADSE 07	7"	9"	6"	2	83	41465
ADSE 08	8"	10"	7"	2	86	41466
ADSE 09	9"	11"	8"	2	90	41467
ADSE 10	10"	12"	9"	2	106	41468
ADSE 12	12"	14"	10"	2	134	41469
ADSE 14	14"	16"	12"	2	166	41470
ADSE 16	16"	16"	12"	3	177	41471
ADSE 18	18"	18"	14"	3	245	41472
ADSE 20	20"	18"	16"	3	296	41473
ADSE 24	24"	18"	16"	4	300	41474

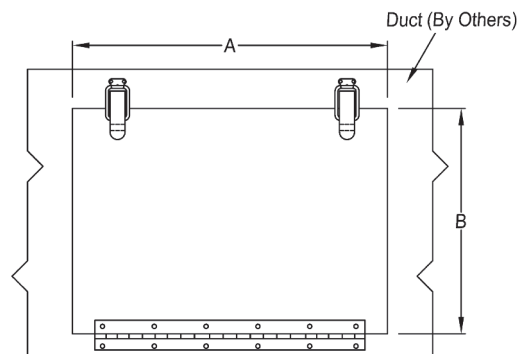

Note: Field assembly of hinge and striker catch to duct required.



- Same Day, Next Day and Standard 2-Day shipping options
- Next day delivery on orders placed as late as 5pm Eastern time
- The largest inventory of Fans, Dampers, and Air Distribution in the country
- Quality products with features and designs that save time and money
- Value by providing a premium service without the premium price



Air Distribution Products stocked		
Series	Description	Types/Sizes
APC	Perforated Diffusers – Curved Blade	191
APM	Perforated Diffusers – Modular	75
APA	Perforated Diffusers – Deflectors	12
APR	Perforated Returns	94
APX	Perforated Return Screens	7
AC	Cone Diffusers – Lay-in	16
AO	Architectural Plaque Diffusers – Lay-in	16
AL	Louvered Diffusers – Surface & Lay-in	20
AM	Modular Diffusers – Surface & Lay-in	27
CB	Curved Blade Diffusers – Surface	30
AR	Round Spun Diffusers – 2 & 3 Cone	18
ALS	Linear Slot Diffusers – 4 ft & 8 ft	32
ALSP	Plenums for Linear Slot Diffusers – 4 ft	20
AAB	Linear Air Bar Diffusers – 10 ft	14
AABP	Plenums for Linear Air Bar – 3 ft, 4 ft & 5 ft	23
DR	Drop Down Diffusers	8
DDV	Double Deflection Registers	129
FBH	Fixed Bar Return Grilles – Surface & Lay-in	244
FBHF1	Filter Return Grilles – Lay-in	7
EC	Egg Crate Return Grilles – Surface & Lay-in	20
ECF1	Egg Crate Filter Grille – Lay-in	6
HLF	Hard Lid Rapid Mount Ceiling Frames	6
OBDB	Opposed Blade Dampers – Black	60
BBD	Round Butterfly Dampers	14
SBD	Round Sliding Blade Dampers	5
STR	Square to Round Adapters – Black Interior	68
RTR	Round to Round Adapters – Black Interior	19

Air Device Products stocked		
Series	Description	Types/Sizes
SDT	Single Duct VAV Terminals	9
COIL	Hot Water Reheat Coils – 1 & 2 Row	14
ATTEN	Attenuators & End Caps	12
PNEU	Pneumatic Controls & Accessories	17
DIGI	Digital Controls & Accessories	14

Air Damper Products stocked		
Series	Description	Types/Sizes
FS3	Vertical F/S dampers, UL Class II, 350°	79
FS3	Corridor F/S dampers, UL Class II, 350°	28
DWD	Dynamic Curtain Type Fire Dampers	11
CRD	Ceiling Radiation Dampers	18
ANGLE	Retaining Angles & Flange Sets	24
RBDE	Round Balancing Damper, Electric Remote Powered	9
RBDEC	Hand Held Controllers, Terminals & Cable	9
RBDDB	Round Balancing Damper, Bowden	9
RBDDBC	Bowden Controllers & Cable	5
RBD	Round Balancing Damper with Quadrant	10
DISC	Disc Damper Kits	12
BDDR	Round Backdraft Dampers	8
BDDS	Backdraft Dampers – Steel	21
BDDA	Backdraft Dampers – Aluminum	11
CD1	Control Dampers – Aluminum	10
SB	Single Blade Economy Balancing Dampers	6
MD	Opposed Blade Balancing Dampers	9
BV	Brick Vents	4
DAL	Fixed Louvers, Drainable Blades & Jamb	6

Access Door Products stocked		
Series	Description	Types/Sizes
ADSM	Classic Sheet Metal Door, Hinged w/Cams	8
ADFR	1.5 HR Fire Rated Doors, UL & CSFM	3
ADMU	Multi-Use Doors, Hinged & Latched	8
ADLP	Low Pressure Spiral Duct Doors w/Latches	12
ADSD	Sandwich Type Spiral Duct Doors w/Knobs	9
ADSO	Oval Access Doors w/Cams & Chains	5
ADZL	Zero Leak Access Doors, Hinged w/Cams	16

Air Delivery Products stocked		
Series	Description	Types/Sizes
DCR	Roof Exhaust, Downblast Direct, UL705	21
BCR	Roof Exhaust, Downblast Belt, UL705	48
BCRU	Roof Exhaust, Upblast Belt, UL762	41
DSI	Inline, Direct Drive, Square, UL705	16
BSI	Inline, Belt Drive, Square, UL705	64
RSV	Round Spun Gravity Ventilators	12
CURB	Canted & Vented Roof Curbs	15
BDDS	Backdraft Dampers – Steel	21
BRO	Broan Ceiling & Cabinet Fans	16
BROI	Broan Inline Adapter Kits	14
JCS	Jacks, Caps & Switches	9
PANA	Panasonic Ceiling Fans	10
PANI	Panasonic Inline & Wall fans	5
CA/R	Round Inline Fans, Steel & Plastic	8
DQ	Dryer Vent Booster Fans – Cleanable	2
ISO	Vibration Isolation Mounts & Hangers	20

Air Duct Products stocked		
Series	Description	Types/Sizes
TFP	Poly Flex Duct	64
TFA	Aluma-Core Flex Duct, 6 ft CBE, Bare	32
SM	Galvanized Saddle Taps, T-Wyes & Elbows	58
SM	Galvanized Spiral Duct, KD Pipe & Caps	38
SM	Galvanized Tapers & Start Collars	33
SM	Galvanized Tee Tops w/Screen	6

Please visit our website for a complete list of products available

Ph 800.322.8676 • www.adp-hvac.com • Fx 800.604.3324

All this ships in **2 Days** or less! Who knew?

ADP
Air Distribution Products



Standard 2 Day Shipping

ADP
Air Device Products



Standard 2 Day Shipping

ADP
Air Damper Products



Standard 2 Day Shipping

ADP
Air Delivery Products



Standard 2 Day Shipping

ADP
Access Door Products



Standard 2 Day Shipping

ADP
Air Duct Products



Standard 2 Day Shipping



Serving the HVAC Industry Since 1952

Ph 800.322.8676 • www.adp-hvac.com • Fx 800.604.3324

9668-D Heinrich Hertz Drive, San Diego, CA 92154