

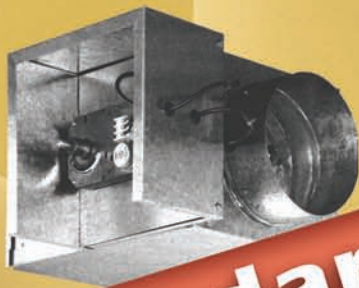

# Air Device Products

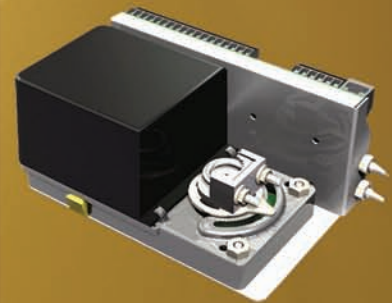

**Standard 2 Day Shipping**





ADP offers standard 2-Day “Quick Ship” service on all the products you see in this catalog at no increase in price for the premium service. For those occasions when even faster shipping is needed we also offer Next Day “Quicker Ship” and Same Day “Quickest Ship” options on most of our products, as follows:

| Shipping Options            | Lead Time (working days) | Percentage Add | Order Cut-Off Time       |
|-----------------------------|--------------------------|----------------|--------------------------|
| <b>Quick Ship orders</b>    | <b>2 Days Max</b>        | <b>No Add</b>  | <b>5:00 pm (Pacific)</b> |
| <b>Quicker Ship orders</b>  | <b>Next Day</b>          | <b>15%</b>     | <b>5:00 pm (Pacific)</b> |
| <b>Quickest Ship orders</b> | <b>Same Day</b>          | <b>25%</b>     | <b>2:00 pm (Pacific)</b> |

**Straight Talk:** While our on-time shipping performance has exceeded 95% for five years running, it is possible that a sudden increase in demand or an unexpected large order could impact our stock, thus our *Quick Ship* options are subject to availability. Please see the Limitations paragraph below for your options, should a shortage occur.

## Terms & Conditions

**Lead Time:** For standard 2-Day *Quick Ship* orders, the lead time clock begins the day after you place your order. For example, if you place your order on a Monday, the next day, Tuesday, is Day 1. You can expect your order to ship no later than Day 2, which would be Wednesday if there are no holidays. Orders entered after 5:00 pm are considered to be entered the next business day.

*Quicker* and *Quickest Ship* orders work similarly. For example, a Next Day *Quicker Ship* order placed on a Monday will ship the next day, Tuesday. Same Day *Quickest Ship* orders must be placed before 2:00 pm Pacific Time to be shipped the same day. Same day local delivery may also be available on orders placed by 10:00 am. Please call for availability.

**Pricing:** All prices are list. Please refer to your current Discount Schedule for applicable multipliers. 2-Day shipping is standard (subject to availability). For all orders under \$350 net, a Small Order Freight Add of \$30 will apply.

**Freight Terms:** All orders are shipped F.O.B. Origin. Actual freight rates will be charged for 2nd Day, Next Day, and Courier shipments, as well as on all orders that do not qualify for Prepaid freight. Please refer to your current Discount Schedule for Freight Factors on orders shipping 500 miles or more from the 92154 zip code.

**Limitations:** While our goal is to ship orders in two days or less, with our accelerated shipping schedule some shortages may occur. As a result, our *Quick Ship* options are subject to availability. Should we encounter a shortage on a qualified freight Prepaid order we will contact you to determine if you wish the entire order to be held until the shortages arrive (so everything ships prepaid) or if we should ship what we have available. Backorders cannot be shipped prepaid. Any items you instruct us to backorder will ship Prepaid & Add.

**Payment terms:** 1% 10, Net 30 from the date of our invoice for customers with approved credit. A service charge of 1.5% per month will be charged and collected on all past due account balances. Credit card payment is also accepted at time of purchase only, no discount allowed. Accounts with balances over 45 days old will be on shipping hold.

**Returns:** Returns will not be accepted unless accompanied by a Return Goods Authorization (RGA) form issued by ADP. Return goods will be inspected upon receipt by ADP and for all products accepted for restocking, 75% of the purchase price (excluding outbound freight) will be refunded. Products which have been installed or damaged (including packaging) are not suitable for restocking and no credit will be given. All returns must be returned to their point of origin, freight prepaid. If requested, we will issue a call tag for items to be returned, in which case return freight charges will be deducted from any credit issued.

**Minimum order:** For all orders under \$350 net a Small Order Freight Add will apply.

**Changes:** All orders are subject to a \$10 change fee per line item changed. Upon receipt of a change order, the date the change order is received becomes the new order receipt date and the lead time clock starts anew. Changes can not be accepted on the day of shipment.

**Cancellations:** Because of our accelerated shipping commitment we begin work on your order immediately upon receipt. Therefore, all orders cancelled after placement or before shipment will be subject to a 15% cancellation charge.

**Damage or Loss:** Unless otherwise agreed, all shipments are made F.O.B. Origin. ADP will not be responsible for delays in delivery by carrier, for loss or damage to merchandise in transit, for reconsignment fees or for storage fees due to delay in delivery. Where shortages or damages occur, details should be noted on the freight bill by the customer at time of delivery and reported to ADP within ten (10) days of shipment. In case of concealed damage, customer should call the carrier immediately to inspect damaged merchandise. With the exception of UPS and Fed-Ex ground shipments, all claims must be filed direct with the carrier by the customer. However, we will gladly assist our customer in attempting to secure prompt and satisfactory settlement.





**Warranty:** ADP warrants our products for a period of twelve (12) months from the date of shipment against defects in materials and workmanship. If a product fails to perform properly within this period, ADP will replace or repair it at our option. This warranty does not extend to and does not cover defects caused by misuse, abuse, accident, improper installation or alteration. This warranty is for materials only and specifically excludes labor for removal or installation, as well as any and all forms of indemnification.

**Force Majeure:** ADP shall not be liable for delays or defaults in delivery caused by floods, fires, storms or other acts of God, by war or act of public enemy or civil disturbance, strikes, lockouts, shortages of labor or raw materials and suppliers (including fuel) or production facilities, transportation service or equipment shortages or failures, actions or any governmental authority, or other conditions beyond our reasonable control.

**Sales:** All sales are governed by the Terms and Conditions found on this page. If you do not accept these terms you must notify us within 24 hours of receiving our Acknowledgement. If you accept delivery of our goods, you will be deemed to have accepted these Terms of Sale in full. You further agree that these Terms of Sale supersede any additional or different terms or conditions contained in your purchase order or in any other agreement between you and ADP.

## Air Distribution Products

9668 Heinrich Hertz Drive #D, San Diego, CA 92154 • Ph: (800) 322-8676 Fx: (800) 604-3324

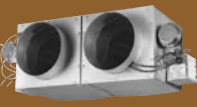
|   |   |  |  |
|---|---|--|--|
|  | Single Duct Terminal Units<br>Pages 1-2 |  | Direct Digital VAV Controls<br>Pages 7-8                       |
|  | Pneumatic VAV Controls<br>Pages 3-4     |  | Water Reheat Coils and<br>Valves for Water Coils<br>Pages 9-10 |
|  | Analog VAV Controls<br>Pages 5-6        |  | Dual Duct Terminal Units<br>Page 11                            |

## Single Duct VAV

### Features:

- Heavy gauge steel housing. Mechanically sealed and gasketed, leak resistant construction
- 1/2" internal insulation, cloth faced to resist air erosion
- Meets requirements of NFPA 90A, NFPA 90B, and UL 181
- Tight close-off damper. Leakage is less than 2% of nominal cfm at 3" SP as rated by ADC Test Code 1062R4
- Rectangular discharge for slip-and-drive cleat duct connection
- Gauge tees for cfm measurement



SDT shown above with optional Control Enclosure

| Inlet Size | Terminal List Pricing <sup>1</sup> |                       |                           | List Pricing for Accessories |               |                        |                       |
|------------|------------------------------------|-----------------------|---------------------------|------------------------------|---------------|------------------------|-----------------------|
|            | SDT<br>Fiberglass<br>Lining        | SDT<br>Foam<br>Lining | SDT<br>Foil-Loc<br>Lining | 1 Row<br>Coil                | 2 Row<br>Coil | Atten.<br>Std. 3ft. KD | End Cap<br>For Atten. |
|            | SKU                                | SKU                   | SKU                       | SKU                          | SKU           | SKU                    | SKU                   |
| 6"         | 220<br>65352                       | 279<br>65342          | 305<br>65126              | 99<br>61100                  | 158<br>61107  | 161<br>61114           | 26<br>71144           |
| 8"         | 241<br>65104                       | 303<br>65119          | 326<br>65128              | 116<br>61101                 | 205<br>61108  | 171<br>61115           | 29<br>71145           |
| 10"        | 279<br>65108                       | 350<br>65121          | 369<br>65130              | 173<br>61102                 | 284<br>61109  | 191<br>61116           | 32<br>71146           |
| 12"        | 293<br>65110                       | 374<br>65122          | 388<br>65131              | 228<br>61103                 | 376<br>61110  | 231<br>61117           | 41<br>71147           |
| 14"        | 371<br>65112                       | 464<br>65340          | 471<br>65132              | 315<br>61104                 | 481<br>61111  | 262<br>61118           | 50<br>71148           |
| 16"        | 395<br>65114                       | 497<br>65353          | 497<br>65133              | 365<br>61105                 | 536<br>61112  | 291<br>61119           | 55<br>71149           |
| 24"x16"    | 546<br>65344                       | 1744<br>65346         | 1551<br>65134             | 462<br>61106                 | 739<br>61113  | 420<br>61120           | 55<br>71150           |

<sup>1</sup> List pricing is for bare terminals only. See page 3-8 for Control options.

• White dots = Low demand items. Check availability before quoting.

| Model                  | Description      | List | SKU   |
|------------------------|------------------|------|-------|
| Inlet Adapter 6" to 4" | 6" to 4" Reducer | 18   | 61154 |
| Inlet Adapter 6" to 5" | 6" to 5" Reducer | 18   | 61155 |

**SDT with optional Control Enclosure**

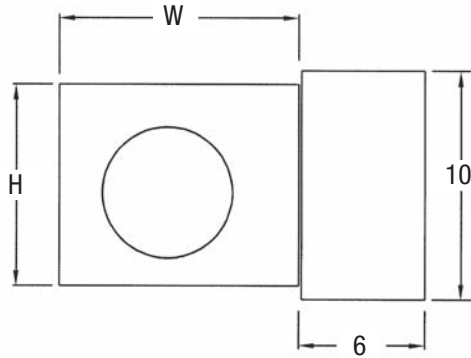

**SDT bare**

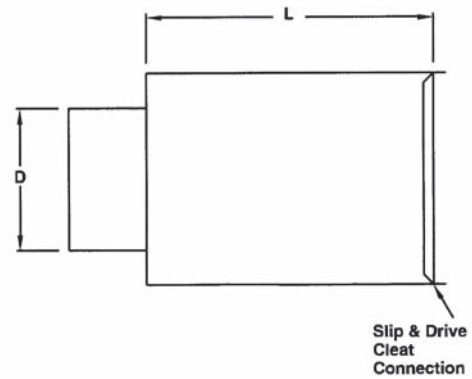
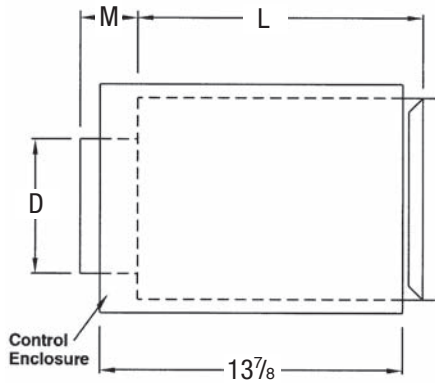
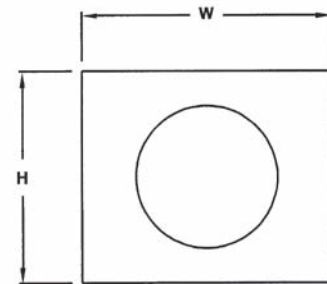

| Inlet Size | CFM Range | D   | L                              | W  | H                              | M  | Weight lbs. |
|------------|-----------|---|--------------------------------|----|--------------------------------|----|-------------|
| 6"         | 0-600     | 5 <sup>7</sup> / <sub>8</sub>                                   | 15 <sup>3</sup> / <sub>4</sub> | 12 | 8                              | 5" | 12          |
| 8"         | 0-1100    | 7 <sup>7</sup> / <sub>8</sub>                                   | 15 <sup>3</sup> / <sub>4</sub> | 12 | 10                             | 5" | 15          |
| 10"        | 0-1700    | 9 <sup>7</sup> / <sub>8</sub>                                   | 15 <sup>3</sup> / <sub>4</sub> | 14 | 12 <sup>1</sup> / <sub>2</sub> | 5" | 18          |
| 12"        | 0-2500    | 11 <sup>7</sup> / <sub>8</sub>                                  | 15 <sup>3</sup> / <sub>4</sub> | 16 | 15                             | 5" | 22          |
| 14"        | 0-3250    | 13 <sup>7</sup> / <sub>8</sub>                                  | 15 <sup>3</sup> / <sub>4</sub> | 20 | 17 <sup>1</sup> / <sub>2</sub> | 5" | 24          |
| 16"        | 0-4100    | 15 <sup>7</sup> / <sub>8</sub>                                  | 15 <sup>3</sup> / <sub>4</sub> | 24 | 18                             | 5" | 29          |
| 24" x 16"  | 0-7200    | 23 <sup>7</sup> / <sub>8</sub> x 15 <sup>7</sup> / <sub>8</sub> | 15 <sup>3</sup> / <sub>4</sub> | 38 | 20                             | 5" | 58          |





CSC 2013



CSC 3017



Pneumatic Actuator



U Bracket

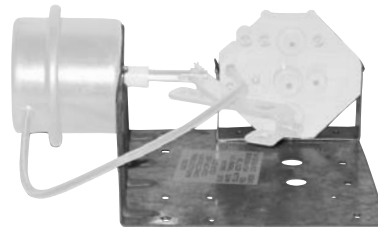

Mounting Plate



Relay 243 0024



TUB 1219 44003  
TUB 1219 440T3



STAT TP970A 2145  
STAT TP970B 2077



STAT 192 840  
STAT 192 841



STAT T4002 301  
STAT T4002 302



STAT 2212 118  
STAT 2212 119

## Pneumatic VAV Controls & Accessories (continued)

### Accessories & Replacement Parts Pricing

| Model              | Description  | List Price | SKU   |
|--------------------|--|------------|-------|
| CSC 2013           | Economy VAV Controller, Direct Acting                                    | 205 •      | 21609 |
| RELAY 243 0024     | Reverse Acting Relay   | 223 •      | 21424 |
| CSC 3017           | Universal VAV Controller, Changeable action                              | 205 •      | 21611 |
| PNEUMATIC ACTUATOR | Pneumatic Actuator, 5-10 psi   | 117        | 61167 |
| MTG PLATE          | Mounting Plate with U-Bracket for actuator and controller                | 17         | 61193 |
| U BRACKET          | U-Bracket  | 6          | 21610 |
| STAT TP970A 2145   | Honeywell Pneumatic T-Stat Kit, Direct Acting, 2 pipe                    | 286        | 22232 |
| STAT TP970B 2077   | Honeywell Pneumatic T-Stat Kit, Reverse Acting, 2 pipe                   | 286        | 22233 |
| STAT 192 840       | Siemens Pneumatic T-Stat Kit, Direct Acting, 2 pipe                      | 293 •      | 21481 |
| STAT 192 841       | Siemens Pneumatic T-Stat Kit, Reverse Acting, 2 pipe                     | 293 •      | 21483 |
| STAT T4002 301     | Johnson Controls T-Stat Conversion Kit, Direct Acting, with White Cover  | 377 •      | 21520 |
| STAT T4002 302     | Johnson Controls T-Stat Conversion Kit, Reverse Acting, with White Cover | 303 •      | 21521 |
| STAT 2212 118      | Invensys Pneumatic T-Stat, Direct Acting, 2 pipe                         | 283        | 21493 |
| STAT 2212 119      | Invensys Pneumatic T-Stat, Reverse Acting, 2 pipe                        | 283        | 21594 |
| TUB 1219 44003     | Pneumatic Tubing 1/4 in., 250 ft. roll, black                            | 125        | 22250 |
| TUB 1219 440T3     | Pneumatic Tubing 1/4 in., 250 ft. roll, twin tube, black                 | 359 •      | 22251 |
| SPECIAL MOD 10D    | Add for mounting and piping pneumatic controls                           | 60         | 61518 |

• White dots = Low demand items. Check availability before quoting.

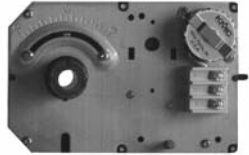

Control Combo 1

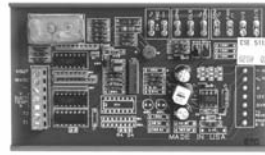

Control Combo 2



STAT 1  
STAT 3  
STAT 4

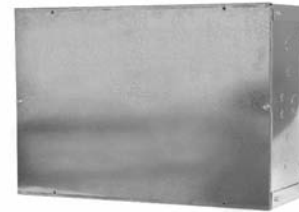

Control Enclosure



T5401



Temperature Sensor



Disc Switch



Calibration Cable

| Control Sequence    | Motor/ Controller Combo | Sensor | Stat   |
|---------------------|-------------------------|--------|--------|
| Cooling Only        | CONTROL COMBO 2         | No     | STAT 1 |
| Auxiliary Heat      | CONTROL COMBO 1         | No     | STAT 3 |
| Auto Changeover     | CONTROL COMBO 2         | Yes    | STAT 3 |
| Proportional Reheat | CONTROL COMBO 2         | No     | STAT 4 |
| Cooling with MWU    | CONTROL COMBO 2         | Yes    | STAT 1 |



## Analog VAV Controls & Accessories (continued)

### Stand-alone Controls – Easy installation, requires no programming

| Model               | Description  | List Price | SKU   |
|---------------------|--|------------|-------|
| CONTROL COMBO 1     | Pressure Independent VAV, Controller/Motor Combo           | 711 •      | 61185 |
| CONTROL COMBO 2     | Pressure Independent VAV, Controller/Motor Combo           | 640 •      | 61187 |
| STAT 1              | Analog Thermostat (Cooling Only or with MWU)               | 247 •      | 61189 |
| STAT 3              | Analog Thermostat (Auto Changeover or Aux. Heat)           | 312 •      | 61190 |
| STAT 4              | Analog Thermostat (Proportional Reheat)                    | 312 •      | 61191 |
| TEMP SENSOR         | Duct Temperature Sensor                                    | 71 •       | 61192 |
| CALIB CABLE         | Thermostat Calibration Cable                               | 106 •      | 61179 |
| T5401 TRANSFORMER   | 120 to 24V, 40 VA, Multi-mount Transformer                 | 25 •       | 22244 |
| DISC SWITCH         | 20A Toggle Switch  | 39         | 61181 |
| CONTROL ENCLOSURE   | NEMA 1 Enclosure, with double backplane 18" x 12" x 6 1/2" | 56         | 61180 |
| ENCLOSURE PARTITION | Control box transformer partition                          | 6          | 61183 |
| ENCLOSURE GROMMET   | Grommet for transformer partition knock-out                | 2          | 61182 |
| SPECIAL MOD 10A     | Add for mounting and wiring of electric controls           | 83         | 61515 |
| SPECIAL MOD 10E     | Add for mounting of transformer and/or disconnect switch   | 39         | 61519 |

• White dots = Low demand items. Check availability before quoting.

## Thermostat Wire

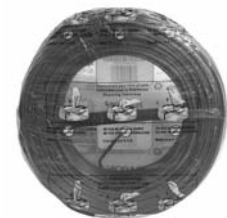

Thermostat Wire

| Model       | Description                  | List Price | SKU   |
|-------------|------------------------------|------------|-------|
| 55302 55 07 | 2 Conductor Wire, 500' Roll  | 211 •      | 22264 |
| 55303 55 07 | 3 Conductor Wire, 500' Roll  | 321 •      | 22265 |
| 55304 55 07 | 4 Conductor Wire, 250' Roll  | 217 •      | 22266 |
| 55305 55 07 | 5 Conductor Wire, 250' Roll  | 234 •      | 22267 |
| 55306 55 07 | 6 Conductor Wire, 250' Roll  | 260 •      | 22268 |
| 55307 55 07 | 7 Conductor Wire, 250' Roll  | 343 •      | 22269 |
| 55308 55 07 | 8 Conductor Wire, 250' Roll  | 349 •      | 22270 |
| 55310 54 07 | 10 Conductor Wire, 250' Roll | 490 •      | 22271 |

• White dots = Low demand items. Check availability before quoting.

## EVC/EVCB Controller/Actuator

### Features:

- Functions as a stand-alone VAV terminal
- Pressure independent digital controller/actuator
- Field-selectable parameters allow entry and updating of setpoint and control parameters via the room sensor
- Integral shaft-mount of the one-piece VAV Actuator further reduces installation and set up time
- Advanced PID control minimizes offset and maintains tighter setpoint control
- Return to service from power failure without operator intervention
- Also BACnet® BTL approved (Model EVCB)



EVC/EVCB

## TRL25 Stat

### Features:

- Large LCD with backlight
- Icon driven menus
- 1 line text
- 4 push buttons



TRL25

### How It Works:

The EVC/EVCB DDC controller can be used as a stand-alone control or part of a BACnet® building automation system. Applications include:

- VAV/CV cooling only (application 07)
- VAV/CV with hot water reheat (application 06)
- VAV cooling/heating auto changeover (application 08)

Controller can be set in the field using the wall sensor menus. Tag, box size, maximum cfm, minimum cfm, and application number must be supplied with order if programming is desired.

| Model               | Description  | List Price | SKU   |
|---------------------|--|------------|-------|
| EVC74RIT2S          | EVC Stand-alone DDC Controller/Actuator                    | 704 •      | 74100 |
| EVCB74RIT2S         | EVC BACnet® DDC Controller/Actuator                        | 870 •      | 74101 |
| TRL25               | Room temperature sensor (stat) with service port*          | 190 •      | 74102 |
| STC8-11             | Changeover Sensor  | 84 •       | 74103 |
| CONTROL ENCLOSURE   | NEMA 1 Enclosure, with double backplane 18" x 12" x 6 1/2" | 56         | 61180 |
| ENCLOSURE PARTITION | Control box transformer partition                          | 6          | 61183 |
| ENCLOSURE GROMMET   | Grommet for transformer partition knock-out                | 2          | 61182 |
| T5401               | 120 to 24V, 40 VA, multi-mount transformer                 | 25 •       | 22244 |
| DISC SWITCH         | 20A toggle switch  | 39         | 61181 |
| 75908 05 23         | 18 AWG. 8 conductor wire, 500' roll                        | 1049 •     | 22283 |
| TOOL 33 296         | Crimper/cutter/stripper, RJ11/RJ45                         | 297 •      | 13271 |
| CONNECTOR RJ45      | RJ45 Plug, 8 position                                      | 2          | 13325 |
| SPECIAL MOD 10A     | Add for mounting and wiring of EVC/EVCB control**          | 83         | 61514 |
| SPECIAL MOD 10B     | Add for programming (optional)                             | 55         | 61516 |
| SPECIAL MOD 10E     | Add for mounting of transformer and/or disconnect switch   | 39         | 61519 |

• White dots = Low demand items. Check availability before quoting.

\*Service Port used in EVCB BACnet® Applications only

\*\*Or customer furnished control

EVC/EVCB Controllers and TRL25 thermostats have an RJ45 jack. Use the 8-conductor wire, RJ45 plug and crimping tool to build your own cable to the length you need.

## Features:

- Copper tubing, Aluminum fins, Galvanized S & Drive casing
- Leak tested to 300 psi
- Slip-and-drive cleat duct connection
- Coil ships separately for field mounting at discharge outlet of terminal unit
- Also suitable for remote duct mounting

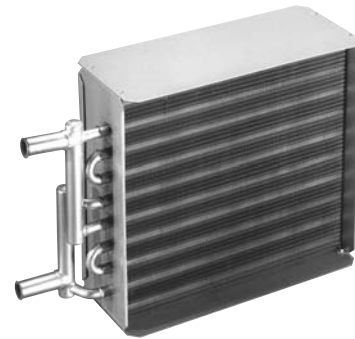

All Dimensions Are In Inches

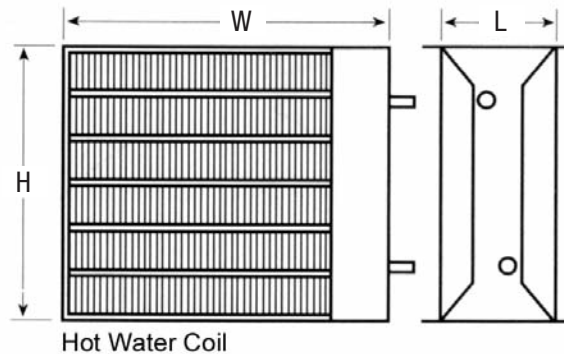

| Box Size | W  | H   | L  | Circuits |       | List Price |       | List Price |       | Wet Weight lbs. |       |
|----------|----|-----|----|----------|-------|------------|-------|------------|-------|-----------------|-------|
|          |    |     |    | 1 Row    | 2 Row | 1 Row      | SKU   | 2 Row      | SKU   | 1 Row           | 2 Row |
| 6"       | 12 | 8   | 5  | Single   | Multi | <b>99</b>  | 61100 | <b>158</b> | 61107 | 5.59            | 7.26  |
| 7", 8"   | 12 | 10  | 5  | Single   | Multi | <b>116</b> | 61101 | <b>205</b> | 61108 | 5.77            | 8.82  |
| 9", 10"  | 14 | 12½ | 5  | Multi    | Multi | <b>173</b> | 61102 | <b>284</b> | 61109 | 8.17            | 11.32 |
| 12"      | 16 | 15  | 5  | Multi    | Multi | <b>228</b> | 61103 | <b>376</b> | 61110 | 10.87           | 15.45 |
| 14"      | 20 | 17½ | 7½ | Multi    | Multi | <b>315</b> | 61104 | <b>481</b> | 61111 | 12.29           | 19.08 |
| 16"      | 24 | 18  | 7½ | Multi    | Multi | <b>365</b> | 61105 | <b>536</b> | 61112 | 14.67           | 21.75 |
| 24"x 16" | 38 | 18  | 5  | Multi    | Multi | <b>462</b> | 61106 | <b>739</b> | 61113 | 21.20           | 32.50 |

**Connections:** Single circuit 1/2" O.D. male solder. Multi circuit, 7/8" O.D. male solder.

| Model | Description             | List Price | SKU   |
|-------|-------------------------|------------|-------|
| T300  | Bicycle Handle Fin Comb | <b>35</b>  | 12583 |
| T100  | Multi-Head Fin Tool Kit | <b>27</b>  | 12582 |



T100



T300

## ZV Series Valves

### Features:

- NPT female threaded
- Small size allows easier installation
- Long stroke for optimal range of control
- High close off pressure



| Model            | Description                       | List Price | SKU   |
|------------------|-----------------------------------|------------|-------|
| VALVE ZV A005YB1 | Zone Valve Body 2-Way 1/2" 0.5 CV | 95         | 74106 |
| VALVE ZV A007YB1 | Zone Valve Body 2-Way 1/2" 0.7 CV | 95         | 74107 |
| VALVE ZV A012YB1 | Zone Valve Body 2-Way 1/2" 1.2 CV | 95         | 74108 |
| VALVE ZV A018YB1 | Zone Valve Body 2-Way 1/2" 1.8 CV | 95         | 74109 |
| VALVE ZV B029YB1 | Zone Valve Body 2-Way 3/4" 2.9 CV | 127        | 74110 |
| VALVE ZV B046YB1 | Zone Valve Body 2-Way 3/4" 4.6 CV | 127        | 74111 |

# Electric Linear Actuator

## X Series Valves

### Features:

- 24VAC/VDC
- Manual Override
- 1m long cable
- Operational status LED
- Direct or Reverse acting field selectable



| Model      | Description                       | List Price | SKU   |
|------------|-----------------------------------|------------|-------|
| ACTE XM000 | Analog modulating actuator        | 237        | 74104 |
| ACTE XT000 | Digital 3 point floating actuator | 221        | 74105 |

## Dual Duct Assemblies

### Features:

- Heavy gauge steel housing. Mechanically sealed and gasketed, leak resistant construction
- 1/2" internal insulation, cloth faced to resist air erosion
- Meets requirements of NFPA 90A, NFPA 90B, and UL 181
- Tight close-off damper. Leakage is less than 2% of nominal cfm at 3" SP as rated by ADC Test Code 1062R4
- Rectangular discharge for slip-and-drive cleat duct connection
- Gauge tees for cfm measurement

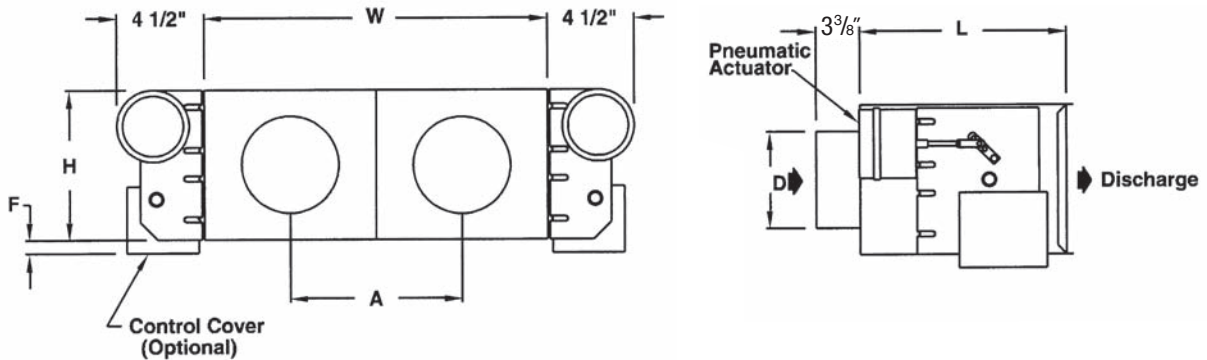

Dual duct assemblies are available in all lining and control options.

*To price any dual duct assembly, price two single duct terminals and add \$55 list.*

| Inlet Size | A                              | W                              | H                              | D                              | L                              | List Price<br>SKU                |
|------------|--------------------------------|--------------------------------|--------------------------------|--------------------------------|--------------------------------|----------------------------------|
| 6"         | 12 <sup>1</sup> / <sub>8</sub> | 24 <sup>1</sup> / <sub>8</sub> | 8                              | 5 <sup>7</sup> / <sub>8</sub>  | 15 <sup>3</sup> / <sub>4</sub> | 55<br>61153<br>(Mounting<br>SKU) |
| 7"         | 12 <sup>1</sup> / <sub>8</sub> | 24 <sup>1</sup> / <sub>8</sub> | 10                             | 6 <sup>7</sup> / <sub>8</sub>  | 15 <sup>3</sup> / <sub>4</sub> |                                  |
| 8"         | 12 <sup>1</sup> / <sub>8</sub> | 24 <sup>1</sup> / <sub>8</sub> | 10                             | 7 <sup>7</sup> / <sub>8</sub>  | 15 <sup>3</sup> / <sub>4</sub> |                                  |
| 9"         | 14 <sup>1</sup> / <sub>8</sub> | 28 <sup>1</sup> / <sub>8</sub> | 12 <sup>1</sup> / <sub>2</sub> | 8 <sup>7</sup> / <sub>8</sub>  | 15 <sup>3</sup> / <sub>4</sub> |                                  |
| 10"        | 14 <sup>1</sup> / <sub>8</sub> | 28 <sup>1</sup> / <sub>8</sub> | 12 <sup>1</sup> / <sub>2</sub> | 9 <sup>7</sup> / <sub>8</sub>  | 15 <sup>3</sup> / <sub>4</sub> |                                  |
| 12"        | 16 <sup>1</sup> / <sub>8</sub> | 32 <sup>1</sup> / <sub>8</sub> | 15                             | 11 <sup>7</sup> / <sub>8</sub> | 15 <sup>3</sup> / <sub>4</sub> |                                  |
| 14"        | 20 <sup>1</sup> / <sub>8</sub> | 40 <sup>1</sup> / <sub>8</sub> | 17 <sup>1</sup> / <sub>2</sub> | 13 <sup>7</sup> / <sub>8</sub> | 15 <sup>3</sup> / <sub>4</sub> |                                  |
| 16"        | 24 <sup>1</sup> / <sub>8</sub> | 48 <sup>1</sup> / <sub>8</sub> | 18                             | 15 <sup>7</sup> / <sub>8</sub> | 15 <sup>3</sup> / <sub>4</sub> |                                  |

See page 1 for single duct terminal pricing.





- Same Day, Next Day and Standard 2-Day shipping options
- Next day delivery on orders placed as late as 5pm Eastern time
- The largest inventory of Fans, Dampers, and Air Distribution in the country
- Quality products with features and designs that save time and money
- Value by providing a premium service without the premium price



| Air Distribution Products stocked |  |             |
|-----------------------------------|--|-------------|
| Series                            | Description                                    | Types/Sizes |
| APC                               | Perforated Diffusers – Curved Blade            | 191         |
| APM                               | Perforated Diffusers – Modular                 | 75          |
| APA                               | Perforated Diffusers – Deflectors              | 12          |
| APR                               | Perforated Returns                             | 94          |
| APX                               | Perforated Return Screens                      | 7           |
| AC                                | Cone Diffusers – Lay-in                        | 16          |
| AO                                | Architectural Plaque Diffusers – Lay-in        | 16          |
| AL                                | Louvered Diffusers – Surface & Lay-in          | 20          |
| AM                                | Modular Diffusers – Surface & Lay-in           | 27          |
| CB                                | Curved Blade Diffusers – Surface               | 30          |
| AR                                | Round Spun Diffusers – 2 & 3 Cone              | 18          |
| ALS                               | Linear Slot Diffusers – 4 ft & 8 ft            | 32          |
| ALSP                              | Plenums for Linear Slot Diffusers – 4 ft       | 20          |
| AAB                               | Linear Air Bar Diffusers – 10 ft               | 14          |
| AABP                              | Plenums for Linear Air Bar – 3 ft, 4 ft & 5 ft | 23          |
| DR                                | Drop Down Diffusers                            | 8           |
| DDV                               | Double Deflection Registers                    | 129         |
| FBH                               | Fixed Bar Return Grilles – Surface & Lay-in    | 244         |
| FBHF1                             | Filter Return Grilles – Lay-in                 | 7           |
| EC                                | Egg Crate Return Grilles – Surface & Lay-in    | 20          |
| ECF1                              | Egg Crate Filter Grille – Lay-in               | 6           |
| HLF                               | Hard Lid Rapid Mount Ceiling Frames            | 6           |
| OBDB                              | Opposed Blade Dampers – Black                  | 60          |
| BBD                               | Round Butterfly Dampers                        | 14          |
| SBD                               | Round Sliding Blade Dampers                    | 5           |
| STR                               | Square to Round Adapters – Black Interior      | 68          |
| RTR                               | Round to Round Adapters – Black Interior       | 19          |

| Air Device Products stocked |                                    |             |
|-----------------------------|------------------------------------|-------------|
| Series                      | Description                        | Types/Sizes |
| SDT                         | Single Duct VAV Terminals          | 9           |
| COIL                        | Hot Water Reheat Coils – 1 & 2 Row | 14          |
| ATTEN                       | Attenuators & End Caps             | 12          |
| PNEU                        | Pneumatic Controls & Accessories   | 17          |
| DIGI                        | Digital Controls & Accessories     | 14          |

| Air Damper Products stocked |   |             |
|-----------------------------|---|-------------|
| Series                      | Description                                     | Types/Sizes |
| FS3                         | Vertical F/S dampers, UL Class II, 350°         | 79          |
| FS3                         | Corridor F/S dampers, UL Class II, 350°         | 28          |
| DWD                         | Dynamic Curtain Type Fire Dampers               | 11          |
| CRD                         | Ceiling Radiation Dampers                       | 18          |
| ANGLE                       | Retaining Angles & Flange Sets                  | 24          |
| RBDE                        | Round Balancing Damper, Electric Remote Powered | 9           |
| RBDEC                       | Hand Held Controllers, Terminals & Cable        | 9           |
| RBDDB                       | Round Balancing Damper, Bowden                  | 9           |
| RBDDBC                      | Bowden Controllers & Cable                      | 5           |
| RBD                         | Round Balancing Damper with Quadrant            | 10          |
| DISC                        | Disc Damper Kits                                | 12          |
| BDDR                        | Round Backdraft Dampers                         | 8           |
| BDDS                        | Backdraft Dampers – Steel                       | 21          |
| BDDA                        | Backdraft Dampers – Aluminum                    | 11          |
| CD1                         | Control Dampers – Aluminum                      | 10          |
| SB                          | Single Blade Economy Balancing Dampers          | 6           |
| MD                          | Opposed Blade Balancing Dampers                 | 9           |
| BV                          | Brick Vents                                     | 4           |
| DAL                         | Fixed Louvers, Drainable Blades & Jamb          | 6           |

| Access Door Products stocked |  |             |
|------------------------------|--|-------------|
| Series                       | Description                              | Types/Sizes |
| ADSM                         | Classic Sheet Metal Door, Hinged w/Cams  | 8           |
| ADFR                         | 1.5 HR Fire Rated Doors, UL & CSFM       | 3           |
| ADMU                         | Multi-Use Doors, Hinged & Latched        | 8           |
| ADLP                         | Low Pressure Spiral Duct Doors w/Latches | 12          |
| ADSD                         | Sandwich Type Spiral Duct Doors w/Knobs  | 9           |
| ADSO                         | Oval Access Doors w/Cams & Chains        | 5           |
| ADZL                         | Zero Leak Access Doors, Hinged w/Cams    | 16          |

| Air Delivery Products stocked |                                       |             |
|-------------------------------|---------------------------------------|-------------|
| Series                        | Description                           | Types/Sizes |
| DCR                           | Roof Exhaust, Downblast Direct, UL705 | 21          |
| BCR                           | Roof Exhaust, Downblast Belt, UL705   | 48          |
| BCRU                          | Roof Exhaust, Upblast Belt, UL762     | 41          |
| DSI                           | Inline, Direct Drive, Square, UL705   | 16          |
| BSI                           | Inline, Belt Drive, Square, UL705     | 64          |
| RSV                           | Round Spun Gravity Ventilators        | 12          |
| CURB                          | Canted & Vented Roof Curbs            | 15          |
| BDDS                          | Backdraft Dampers – Steel             | 21          |
| BRO                           | Broan Ceiling & Cabinet Fans          | 16          |
| BROI                          | Broan Inline Adapter Kits             | 14          |
| JCS                           | Jacks, Caps & Switches                | 9           |
| PANA                          | Panasonic Ceiling Fans                | 10          |
| PANI                          | Panasonic Inline & Wall fans          | 5           |
| CA/R                          | Round Inline Fans, Steel & Plastic    | 8           |
| DQ                            | Dryer Vent Booster Fans – Cleanable   | 2           |
| ISO                           | Vibration Isolation Mounts & Hangers  | 20          |

| Air Duct Products stocked |   |             |
|---------------------------|---|-------------|
| Series                    | Description                             | Types/Sizes |
| TFP                       | Poly Flex Duct                          | 64          |
| TFA                       | Aluma-Core Flex Duct, 6 ft CBE, Bare    | 32          |
| SM                        | Galvanized Saddle Taps, T-Wyes & Elbows | 58          |
| SM                        | Galvanized Spiral Duct, KD Pipe & Caps  | 38          |
| SM                        | Galvanized Tapers & Start Collars       | 33          |
| SM                        | Galvanized Tee Tops w/Screen            | 6           |

Please visit our website for a complete list of products available

Ph 800.322.8676 • [www.adp-hvac.com](http://www.adp-hvac.com) • Fx 800.604.3324

# All this ships in **2 Days** or less! Who knew?

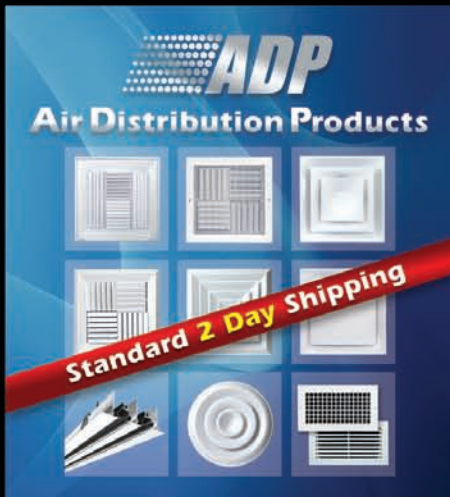

**ADP**  
Air Distribution Products

Standard 2 Day Shipping

This banner features a blue background with a grid of nine images showing various air distribution products such as diffusers, registers, and grilles.



**ADP**  
Air Device Products

Standard 2 Day Shipping

This banner features a yellow background with a grid of nine images showing various air device products including coils, filters, and control boxes.

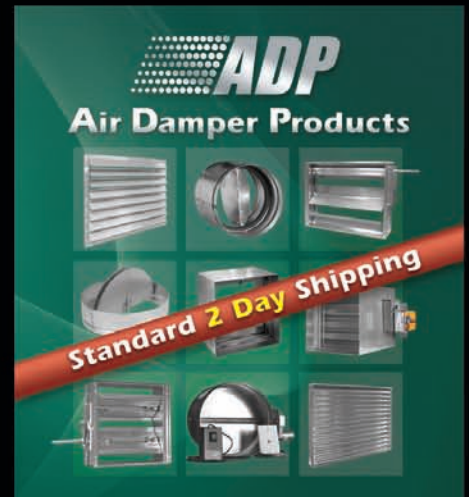

**ADP**  
Air Damper Products

Standard 2 Day Shipping

This banner features a green background with a grid of nine images showing various air damper products such as dampers, valves, and actuators.



**ADP**  
Air Delivery Products

Standard 2 Day Shipping

This banner features a yellow background with a grid of nine images showing various air delivery products including fans, blowers, and air movers.



**ADP**  
Access Door Products

Standard 2 Day Shipping

This banner features a red background with a grid of nine images showing various access door products including doors, panels, and frames.



**ADP**  
Air Duct Products

Standard 2 Day Shipping

This banner features a blue background with a grid of nine images showing various air duct products including elbows, tees, and straight sections.



*Serving the HVAC Industry Since 1952*

Ph 800.322.8676 • [www.adp-hvac.com](http://www.adp-hvac.com) • Fx 800.604.3324

9668-D Heinrich Hertz Drive, San Diego, CA 92154