

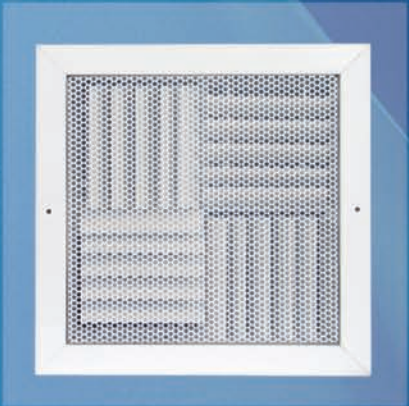

Air Distribution Products



Standard 2 Day Shipping



ADP offers standard 2-Day “Quick Ship” service on all the products you see in this catalog at no increase in price for the premium service. For those occasions when even faster shipping is needed we also offer Next Day “Quicker Ship” and Same Day “Quickest Ship” options on most of our products, as follows:

| Shipping Options | Lead Time (working days) | Percentage Add | Order Cut-Off Time |
|----------------------|--------------------------|----------------|--------------------|
| Quick Ship orders | 2 Days Max | No Add | 5:00 pm (Pacific) |
| Quicker Ship orders | Next Day | 15% | 5:00 pm (Pacific) |
| Quickest Ship orders | Same Day | 25% | 2:00 pm (Pacific) |

Straight Talk: While our on-time shipping performance has exceeded 95% for five years running, it is possible that a sudden increase in demand or an unexpected large order could impact our stock, thus our Quick Ship options are subject to availability. Please see the Limitations paragraph below for your options, should a shortage occur.

Terms & Conditions

Lead Time: For standard 2-Day Quick Ship orders, the lead time clock begins the day after you place your order. For example, if you place your order on a Monday, the next day, Tuesday, is Day 1. You can expect your order to ship no later than Day 2, which would be Wednesday if there are no holidays. Orders entered after 5:00pm are considered to be entered the next business day.

Quicker and Quickest Ship orders work similarly. For example, a Next Day Quicker Ship order placed on a Monday will ship the next day, Tuesday. Same Day Quickest Ship orders must be placed before 2:00pm Pacific Time to be shipped the same day. Same day local delivery may also be available on orders placed by 10:00 am. Please call for availability.

Pricing: All prices are list. Please refer to your current Discount Schedule for applicable multipliers. 2-Day shipping is standard (subject to availability). For all orders under \$350 net, a Small Order Freight Add of \$30 will apply.

Freight Terms: All orders are shipped F.O.B. Origin. Actual freight rates will be charged for 2nd Day, Next Day, and Courier shipments, as well as on all orders that do not qualify for Prepaid freight. Please refer to your current Discount Schedule for Freight Factors on orders shipping 500 miles or more from the 92154 zip code.

Limitations: While our goal is to ship orders in two days or less, with our accelerated shipping schedule some shortages may occur. As a result, our Quick Ship options are subject to availability. Should we encounter a shortage on a qualified freight Prepaid order we will contact you to determine if you wish the entire order to be held until the shortages arrive (so everything ships prepaid) or if we should ship what we have available. Backorders cannot be shipped prepaid. Any items you instruct us to backorder will ship Prepaid & Add.

Payment terms: 1% 10, Net 30 from the date of our invoice for customers with approved credit. A service charge of 1.5% per month will be charged and collected on all past due account balances. Credit card payment is also accepted at time of purchase only, no discount allowed. Accounts with balances over 45 days old will be on shipping hold.

Returns: Returns will not be accepted unless accompanied by a Return Goods Authorization (RGA) form issued by ADP. Return goods will be inspected upon receipt by ADP and for all products accepted for restocking, 75% of the purchase price (excluding outbound freight) will be refunded. Products which have been installed or damaged (including packaging) are not suitable for restocking and no credit will be given. All returns must be returned to their point of origin, freight prepaid. If requested, we will issue a call tag for items to be returned, in which case return freight charges will be deducted from any credit issued.

Minimum order: For all orders under \$350 net a Small Order Freight Add will apply.

Changes: All orders are subject to a \$10 change fee per line item changed. Upon receipt of a change order, the date the change order is received becomes the new order receipt date and the lead time clock starts anew. Changes can not be accepted on the day of shipment.

Cancellations: Because of our accelerated shipping commitment we begin work on your order immediately upon receipt. Therefore, all orders cancelled after placement or before shipment will be subject to a 15% cancellation charge.

Damage or Loss: Unless otherwise agreed, all shipments are made F.O.B. Origin. ADP will not be responsible for delays in delivery by carrier, for loss or damage to merchandise in transit, for reconsignment fees or for storage fees due to delay in delivery. Where shortages or damages occur, details should be noted on the freight bill by the customer at time of delivery and reported to ADP within ten (10) days of shipment. In case of concealed damage, customer should call the carrier immediately to inspect damaged merchandise. With the exception of UPS and Fed-Ex ground shipments, all claims must be filed direct with the carrier by the customer. However, we will gladly assist our customer in attempting to secure prompt and satisfactory settlement.











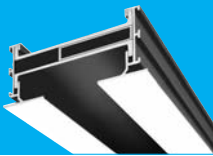
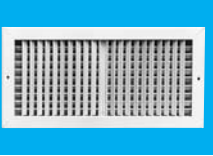
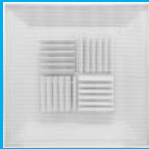
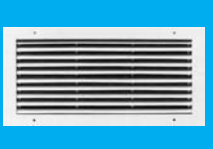

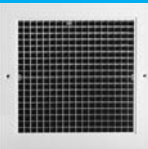
Warranty: ADP warrants our products for a period of twelve (12) months from the date of shipment against defects in materials and workmanship. If a product fails to perform properly within this period, ADP will replace or repair it at our option. This warranty does not extend to and does not cover defects caused by misuse, abuse, accident, improper installation or alteration. This warranty is for materials only and specifically excludes labor for removal or installation, as well as any and all forms of indemnification.

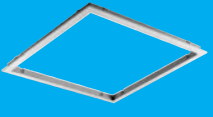
Force Majeure: ADP shall not be liable for delays or defaults in delivery caused by floods, fires, storms or other acts of God, by war or act of public enemy or civil disturbance, strikes, lockouts, shortages of labor or raw materials and suppliers (including fuel) or production facilities, transportation service or equipment shortages or failures, actions or any governmental authority, or other conditions beyond our reasonable control.

Sales: All sales are governed by the Terms and Conditions found on this page. If you do not accept these terms you must notify us within 24 hours of receiving our Acknowledgement. If you accept delivery of our goods, you will be deemed to have accepted these Terms of Sale in full. You further agree that these Terms of Sale supersede any additional or different terms or conditions contained in your purchase order or in any other agreement between you and ADP.

Air Distribution Products

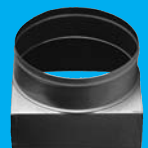
9668 Heinrich Hertz Drive #D, San Diego, CA 92154 • Ph: (800) 322-8676 Fx: (800) 604-3324

| | | | |
|---|--|--|---|
|  | Linear Diffusers & Plenums Pages 1-4 |  | Supply Registers Pages 29-30 |
|  | Perforated Diffusers & Returns Pages 5-18 |  | Bar Type Returns Pages 31-34 |
|  | Square Cone Diffusers Page 19 |  | Egg Crate Returns Pages 34-36 |
|  | Architectural Plaque Diffusers Page 20 |  | Hard Ceiling Frames & Touch-up Paint Page 36 |
|  | Modular Diffusers Pages 21-22 |  | Specialty Diffusers Pages 37-38 |
|  | Louver Face Diffusers Pages 23-25 |  | Accessory Dampers Pages 39-40 |
|  | Curved Blade Diffusers Page 26 |  | Neck Adapters Pages 41-42 |
|  | Round Diffusers Pages 27-28 |  | Alphabetical Index Page 43 |

AAB

Extruded Aluminum • For ceilings and walls

Features:

- Easy-to-handle 10 ft. lengths
- No special clips required for mounting
- Split 2-piece Weir Gate controls both air volume and direction
- Weirs are individually adjustable in 24" sections
- Deep serrations on Type HF (hidden flange design) provide for superior mud adhesion and crack-free installations
- Baked enamel finish, white border with black pattern controllers



Air Bar

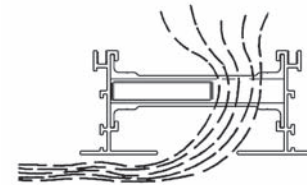

Standard Weirs

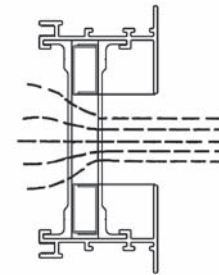

Jet Pair Weirs

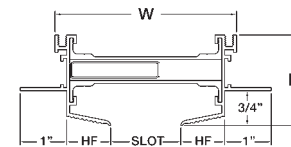

Type HF (1-Slot)
Tape & Mud

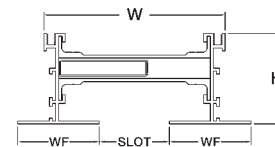

Type WF (1-Slot)
Exposed flange

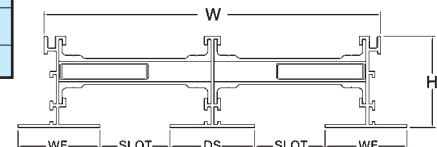

Type WF (2-Slot)
Exposed flange

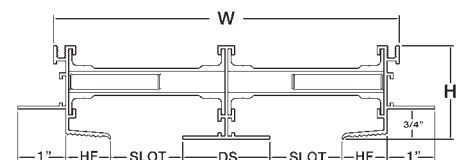

Type HF (2-Slot)
Tape & Mud

| Model | Flange Type | Weir Type | 1-Slot 10 ft. | | | 2-Slot 10 ft. | | |
|--------|-----------------------|-----------|--------------------|------------|-------|--------------------|------------|-------|
| | | | CFM/Ft. @ NC 35 | List Price | SKU | CFM/Ft. @ NC 35 | List Price | SKU |
| AAB-10 | WF | Standard | 70 | 520 | 53507 | 130 | 840 | 53508 |
| AAB-15 | WF | Standard | 80 | 520 | 53509 | 150 | 840 | 53510 |
| AAB-20 | WF | Standard | 100 | 520 | 53511 | 190 | 840 | 53512 |
| AAB-25 | WF | Standard | 125 | 520 | 53513 | - | - | - |
| AAB-30 | WF | Standard | 150 | 520 | 53514 | - | - | - |
| AAB-10 | HF | Standard | 70 | 580 | 53501 | 130 | 840 | 53528 |
| AAB-15 | HF | Standard | 80 | 580 | 53502 | 150 | 840 | 53529 |
| AAB-20 | HF | Standard | 100 | 580 | 53503 | 190 | 840 | 53530 |
| AAB-10 | WF | Jet Pair | 120 | 520 | 53515 | - | - | - |
| AAB-15 | WF | Jet Pair | 160 | 520 | 53516 | - | - | - |
| AAB-20 | WF | Jet Pair | 200 | 520 | 53517 | - | - | - |
| AAB-10 | HF | Jet Pair | 120 | 580 | 53504 | - | - | - |
| AAB-15 | HF | Jet Pair | 160 | 580 | 53505 | - | - | - |
| AAB-20 | HF | Jet Pair | 200 | 580 | 53506 | - | - | - |
| FSK10* | Field Spacer Kit* | | - | 15 | 53518 | - | 30 | 53523 |
| FSK15* | Field Spacer Kit* | | - | 15 | 53519 | - | 30 | 53524 |
| FSK20* | Field Spacer Kit* | | - | 15 | 53520 | - | 30 | 53525 |
| FSK25* | Field Spacer Kit* | | - | 15 | 53521 | - | - | - |
| FSK30* | Field Spacer Kit* | | - | 15 | 53522 | - | - | - |
| RAH10 | Insulated Return Hood | | - | 60 | 53526 | - | - | - |
| RAH15 | Insulated Return Hood | | - | 60 | 53526 | - | - | - |
| RAH20 | Insulated Return Hood | | - | 60 | 53526 | - | - | - |
| RAH25 | Insulated Return Hood | | - | 60 | 53527 | - | - | - |
| RAH30 | Insulated Return Hood | | - | 60 | 53527 | - | - | - |

* Air Bar is easily field cut to desired length. One Field Spacer Kit is required for each cut.

Note: Splice plates, drywall clips and hanger clips provided as needed – no charge.

Note: For inactive sections and returns the Weir Gates may be removed in the field.

| Model | Slot Width | W Width | | HF Flange Width | WF Flange Width | DS Flange Width | H Height |
|-------|-------------------------------|-------------------------------|--------------------------------|--------------------------------|-------------------------------|---------------------------------|---------------------------------|
| | | 1-Slot | 2-Slot | | | | |
| AAB10 | 1 | 2 ⁷ / ₈ | 5 ³ / ₁₆ | 1 ¹ / ₁₆ | 1 ¹ / ₂ | 1 ⁵ / ₁₆ | 1 ¹¹ / ₁₆ |
| AAB15 | 1 ¹ / ₂ | 3 ⁷ / ₈ | 7 ³ / ₁₆ | 1 ⁵ / ₁₆ | 1 ³ / ₄ | 1 ¹³ / ₁₆ | 1 ¹⁵ / ₁₆ |
| AAB20 | 2 | 4 ⁷ / ₈ | 9 ³ / ₁₆ | 1 ³ / ₁₆ | 2 | 2 ⁵ / ₁₆ | 2 ³ / ₄ |
| AAB25 | 2 ¹ / ₂ | 6 ¹ / ₂ | - | - | 2 ¹ / ₂ | - | 2 ³ / ₄ |
| AAB30 | 3 | 7 | - | - | 2 ¹ / ₂ | - | 2 ³ / ₄ |

Note: Custom curving available. Please call for quote.

Note: Concealed mounting hardware is available for Type WF when Air Bar is not installed with the ceiling grid. Please call for quote.

AABP

Galvanized Steel • Insulated

Features:

- True round or field-cut inlet types
- Galvanized steel construction
- Can be used for supply or ducted return
- Insulation: 1/2" fiberglass
- Material: 24 gauge galvanized steel

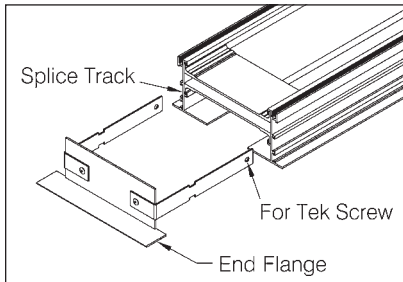

| Model | List Price | SKU |
|-------------|------------|-------|
| AAB10 EF 1S | 4 | 53209 |
| AAB15 EF 1S | 4 | 53210 |
| AAB20 EF 1S | 4 | 53211 |
| AAB25 EF 1S | 4 | 53212 |
| AAB30 EF 1S | 4 | 53213 |
| AAB10 EF 2S | 4 | 53214 |
| AAB15 EF 2S | 4 | 53215 |
| AAB20 EF 2S | 4 | 53216 |

| Model | 3 Ft. (12" inlet) | 3 Ft. (field cut) | 4 Ft. (8" inlet) | 4 Ft. (10" inlet) | 4 Ft. (12" inlet) | 4 Ft. (field cut) | 5 Ft. (12" inlet) | 5 Ft. (field cut) |
|--------------|----------------------|----------------------|---------------------|----------------------|----------------------|----------------------|----------------------|----------------------|
| | List Price SKU | List Price SKU | List Price SKU | List Price SKU | List Price SKU | List Price SKU | List Price SKU | List Price SKU |
| AABP10 1SLOT | 120 • 53170 | 120 • 53173 | 134 53181 | 134 53184 | 134 53187 | 134 53190 | 160 53198 | 160 • 53201 |
| AABP15 1SLOT | 140 • 53171 | 140 • 53174 | 162 53182 | 162 53185 | 162 53188 | 162 53191 | 192 53199 | 192 • 53202 |
| AABP20 1SLOT | 140 • 53172 | 140 • 53175 | 162 53183 | 162 53186 | 162 53189 | 162 53192 | 192 53299 | 192 • 53203 |
| AABP25 1SLOT | - | 156 • 53176 | - | - | - | 174 53193 | - | 206 • 53204 |
| AABP30 1SLOT | - | 156 • 53177 | - | - | - | 174 53194 | - | 206 • 53205 |
| AABP10 2SLOT | - | 154 • 53178 | - | - | - | 172 53195 | - | 204 • 53206 |
| AABP15 2SLOT | - | 170 • 53179 | - | - | - | 188 53196 | - | 220 • 53207 |
| AABP20 2SLOT | - | 194 • 53180 | - | - | - | 212 53197 | - | 244 • 53208 |

• White dots = Low demand items. Check availability before quoting.

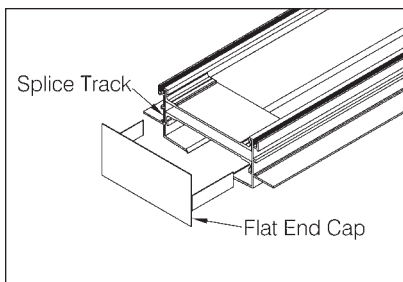

| Model | List Price | SKU |
|-------------|------------|-------|
| AAB10 EC 1S | 4 | 53217 |
| AAB15 EC 1S | 4 | 53218 |
| AAB20 EC 1S | 4 | 53219 |
| AAB25 EC 1S | 4 | 53220 |
| AAB30 EC 1S | 4 | 53221 |
| AAB10 EC 2S | 4 | 53222 |
| AAB15 EC 2S | 4 | 53223 |
| AAB20 EC 2S | 4 | 53224 |

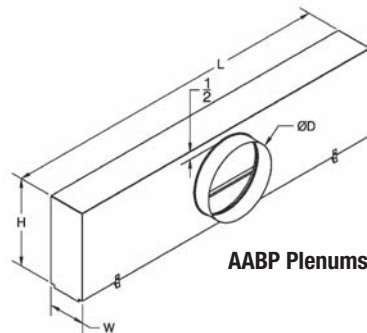

AABP Plenums



AABP ID Inlet Damper (optional)

| Flowbar Plenum Model | W (Width) | | H* (Height) | L (Length) |
|----------------------|-----------|--------|-------------|------------------|
| | 1 Slot | 2 Slot | | |
| AABP10 | 2 7/8 | 5 1/4 | D + 4" | Nominal - 2 1/2" |
| AABP15 | 3 7/8 | 7 1/4 | D + 4" | Nominal - 2 1/2" |
| AABP20 | 4 7/8 | 9 1/4 | D + 4" | Nominal - 2 1/2" |
| AABP25 | 6 1/2 | - | D + 4" | Nominal - 2 1/2" |
| AABP30 | 7 | - | D + 4" | Nominal - 2 1/2" |

Note: All field cut Plenums are 16" high

| AABP ID | |
|-----------|-------------------|
| Size | List Price SKU |
| 8" Round | 82 53563 |
| 10" Round | 90 53564 |
| 12" Round | 98 53565 |

Related items

Round-to-round adapters – Page 42

Linear Slot Diffusers



ALS

Aluminum Frame • Steel Deflectors

Features:

- Ice tong style linear diffusers project a uniform blanket of air that adheres to the ceiling even at low flow rates
- Flanged border, concealed mounting design
- Both the direction and volume of the discharge air can be adjusted gradually by moving the pattern controllers (diagrams below)
- Baked enamel finish, white border with black pattern controller

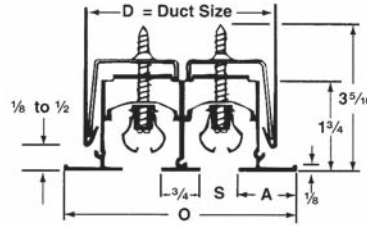

ALS

| Type | S | A | O | D | | | |
|-------|-----|-------|---------|--------|--------|--------|--------|
| | | | | 1 Slot | 2 Slot | 3 Slot | 4 Slot |
| ALS07 | 3/4 | 1 1/8 | D + 3/4 | 2 1/4 | 3 3/4 | 5 1/4 | 6 3/4 |
| ALS10 | 1 | 1 1/8 | D + 3/4 | 2 1/2 | 4 1/4 | 6 | 7 3/4 |

4 FT. T-BAR LENGTHS

| Model | 1 Slot | | | 2 Slot | | | 3 Slot | | | 4 Slot | | |
|------------|-----------------|------------|-------|-----------------|------------|-------|-----------------|------------|-------|-----------------|------------|-------|
| | CFM/Ft. @ NC 35 | List Price | SKU | CFM/Ft. @ NC 35 | List Price | SKU | CFM/Ft. @ NC 35 | List Price | SKU | CFM/Ft. @ NC 35 | List Price | SKU |
| ALS07 4ft. | 35 | 120 | 53100 | 70 | 188 | 53101 | 100 | 256 | 53102 | 140 | 344 | 53103 |
| ALS10 4ft. | 40 | 120 | 53125 | 80 | 188 | 53126 | 110 | 256 | 53127 | 150 | 344 | 53129 |

4 ft. lengths include 3 field spacer kits & 2 hanger brackets

• White dots = Low demand items. Check availability before quoting.

8 FT. FIELD-CUT LENGTHS

| Model | 1 Slot | | | 2 Slot | | | 3 Slot | | | 4 Slot | | |
|------------|-----------------|------------|-------|-----------------|------------|-------|-----------------|------------|-------|-----------------|------------|-------|
| | CFM/Ft. @ NC 35 | List Price | SKU | CFM/Ft. @ NC 35 | List Price | SKU | CFM/Ft. @ NC 35 | List Price | SKU | CFM/Ft. @ NC 35 | List Price | SKU |
| ALS07 8ft. | 35 | 236 | 53104 | 70 | 372 | 53105 | 100 | 512 | 53106 | 140 | 688 | 53107 |
| ALS10 8ft. | 40 | 236 | 53129 | 80 | 372 | 53130 | 110 | 512 | 53131 | 150 | 688 | 53132 |

8 ft. lengths include 4 field spacer kits & 2 hanger brackets

• White dots = Low demand items. Check availability before quoting.

MITERED CORNERS

| Model | 1 Slot | | 2 Slot | | 3 Slot | | 4 Slot | |
|----------|------------|-------|------------|-------|------------|-------|------------|-------|
| | List Price | SKU | List Price | SKU | List Price | SKU | List Price | SKU |
| ALS07 MC | 188 | 53120 | 256 | 53121 | 332 | 53122 | 444 | 53123 |
| ALS10 MC | 188 | 53145 | 256 | 53146 | 332 | 53147 | 444 | 53148 |

• White dots = Low demand items. Check availability before quoting.

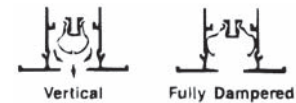

END CAPS & END FLANGES (for hard ceilings)

| Model | 1 Slot | | 2 Slot | | 3 Slot | | 4 Slot | |
|----------|------------|-------|------------|-------|------------|-------|------------|-------|
| | List Price | SKU | List Price | SKU | List Price | SKU | List Price | SKU |
| ALS07 EC | 4 | 53108 | 4 | 53109 | 4 | 53110 | 4 | 53111 |
| ALS10 EC | 4 | 53133 | 4 | 53134 | 4 | 53135 | 4 | 53136 |
| ALS07 EF | 4 | 53112 | 4 | 53113 | 4 | 53114 | 4 | 53115 |
| ALS10 EF | 4 | 53137 | 4 | 53138 | 4 | 53139 | 4 | 53140 |

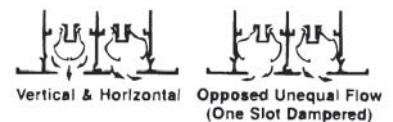
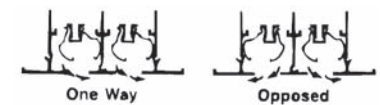

ALSP

Galvanized Steel • Insulated

Features:

- Fits type ALS linear slot diffusers
- End caps can be turned to allow installation on continuous runs of ALS diffusers
- Can be used for supply or ducted return
- Insulation: 1/2" fiberglass
- Material: 24 gauge galvanized steel
- Plenums are 4 ft. long with choice of:
 - Low profile design with 8" oval inlets
 - Round inlets, 6" to 12" in diameter
 - Field cut inlets on three and four slot models

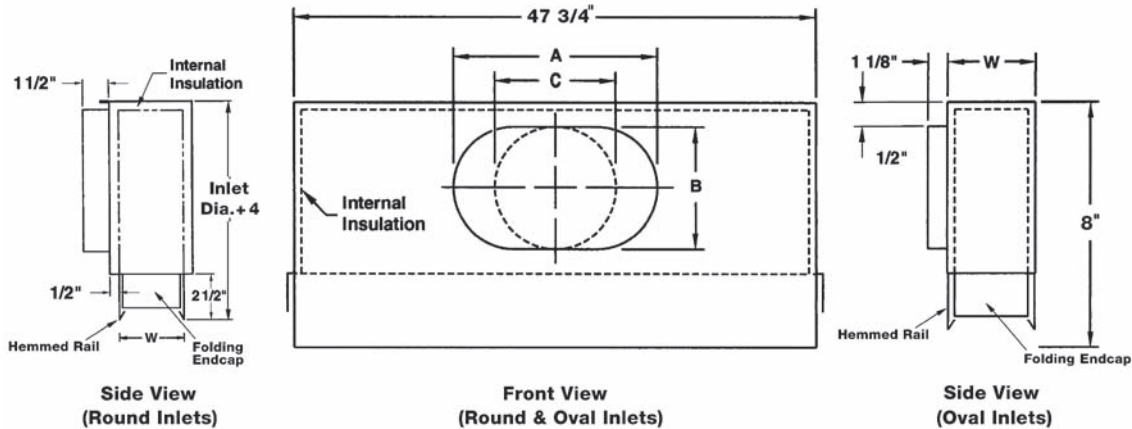

Round Inlets

| No. of Slots | A | B | W (Width) | |
|--------------|-------------------------------|-------------------------------|---------------------------------|--------------------------------|
| | | | ALSP 07 (3/4" Slots) | ALSP 10 (1" Slots) |
| | | | 1 | 9 ³ / ₈ |
| 2 | 9 ³ / ₈ | 5 ¹ / ₄ | 3 ¹⁵ / ₁₆ | 4 ⁷ / ₁₆ |

| No. of Slots | C Inlet Dia. | W (Width) | |
|--------------|----------------------|-------------------------------|-------------------------------|
| | | ALSP 07 (3/4" Slots) | ALSP 10 (1" Slots) |
| 1 | Duct Dia. minus 1/4" | 2 ⁵ / ₈ | 2 ⁷ / ₈ |
| 2 | | 4 ¹ / ₈ | 4 ⁵ / ₈ |
| 3 | | 5 ⁵ / ₈ | 6 ³ / ₈ |
| 4 | | 7 ¹ / ₈ | 8 ¹ / ₈ |



ALSP ID Inlet Damper (optional)

| ALSP07 (3/4" Slot) | | | | | ALSP10 (1" Slot) | | | | |
|--------------------|---|---|---|---|------------------|---|---|---|---|
| Inlet Size | 1 Slot List Price <small>SKU</small> | 2 Slot List Price <small>SKU</small> | 3 Slot List Price <small>SKU</small> | 4 Slot List Price <small>SKU</small> | Inlet Size | 1 Slot List Price <small>SKU</small> | 2 Slot List Price <small>SKU</small> | 3 Slot List Price <small>SKU</small> | 4 Slot List Price <small>SKU</small> |
| 6" Round | 128 53150 | 156 53154 | 164 53158 | 174 53159 | 6" Round | 128 53160 | 156 53164 | 164 53168 | 174 53169 |
| 8" Round | 128 53151 | 156 53155 | | | 8" Round | 128 53161 | 156 53165 | | |
| 10" Round | 128 53152 | 156 53156 | | | 10" Round | 128 53162 | 156 53166 | | |
| 12" Round | 128 53153 | 156 53157 | | | 12" Round | 128 53163 | 156 53167 | | |
| 8" Oval* | 120 51428 | 138 51429 | - | - | 8" Oval* | 120 51430 | 138 51431 | - | - |

| ALSP ID | |
|-----------|----------------------------------|
| Size | List Price <small>SKU</small> |
| 6" Round | 74 53562 |
| 8" Round | 82 53563 |
| 10" Round | 90 53564 |
| 12" Round | 98 53565 |
| 8" Oval* | 82 51432 |

Oval To Round Adapters (optional)



| | | | |
|--------------------------|-------------|----|-------|
| *Oval to Round Adapters: | OTR 0905 06 | 78 | 71174 |
| | OTR 0905 08 | 78 | 71175 |

Related items

Round-to-round adapters – Page 42

Perforated Ceiling Diffusers – Curved Blade – Lay-in



APC3

Steel • Curved Blade Core • Adjustable Discharge Pattern

Features:

- Classic Curved Blade Perf diffuser
- Round or square neck
- Includes earthquake tabs and lances
- 1, 2, 2C, 3 or 4-Way blow pattern is factory set
- Discharge pattern can be adjusted from horizontal to vertical
- 24" x 24" square lay-in ceiling module with removable screen
- Perforated face has industry standard 3/16" holes on 1/4" staggered centers
- Powder coated epoxy finish; white perf on black backpan, or white on white

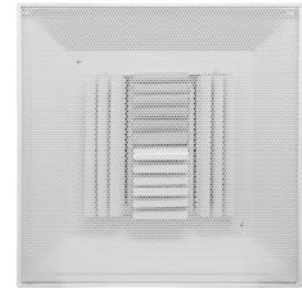

APC3

| Integral round neck sizes | | | | | | | |
|---------------------------|-----------------|-------------------|-------------------|-------------------|---------------------------|-------------------|-------------------|
| Duct Size | Max CFM @ NC 35 | All white | | | White with black interior | | |
| | | List Price APC3FW | List Price APC3NW | List Price APC3DW | List Price APC3FB | List Price APC3NB | List Price APC3DB |
| | | SKU | SKU | SKU | SKU | SKU | SKU |
| 6" | 150 | 68 52218 | 76 52233 | 84 51500 | 80 Ask | 88 Ask | 96 Ask |
| 8" | 240 | 68 52220 | 76 52235 | 84 51510 | 80 Ask | 88 Ask | 96 Ask |
| 10" | 360 | 70 52222 | 78 52237 | 86 51520 | 82 Ask | 90 Ask | 98 Ask |
| 12" | 490 | 70 52224 | 78 52239 | 86 51530 | 82 Ask | 90 Ask | 98 Ask |
| 14" | 640 | 72 52226 | 80 52241 | 88 51540 | 84 Ask | 92 Ask | 100 Ask |
| 16" | 810 | 76 52228 | 84 52243 | 92 51550 | 88 Ask | 98 Ask | 104 Ask |

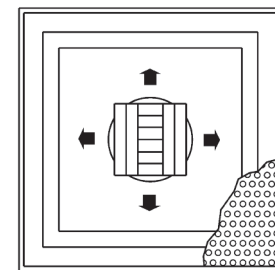

Round Neck
(4-Way Standard)

| Integral square neck sizes | | | | | | | |
|----------------------------|-----------------|-------------------|-------------------|-------------------|---------------------------|-------------------|-------------------|
| Duct Size | Max CFM @ NC 35 | All white | | | White with black interior | | |
| | | List Price APC3FW | List Price APC3NW | List Price APC3DW | List Price APC3FB | List Price APC3NB | List Price APC3DB |
| | | SKU | SKU | SKU | SKU | SKU | SKU |
| 6" x 6" | 180 | 76 52219 | 84 52234 | 92 Ask | 88 Ask | 96 Ask | 104 Ask |
| 8" x 8" | 300 | 76 52221 | 84 52236 | 92 Ask | 88 Ask | 96 Ask | 104 Ask |
| 10" x 10" | 440 | 78 52223 | 86 52238 | 94 Ask | 90 Ask | 98 Ask | 106 Ask |
| 12" x 12" | 600 | 78 52225 | 86 52240 | 94 Ask | 90 Ask | 98 Ask | 106 Ask |
| 14" x 14" | 750 | 80 52227 | 88 52242 | 96 Ask | 92 Ask | 100 Ask | 108 Ask |
| 16" x 16" | 950 | 84 52229 | 92 52244 | 100 Ask | 96 Ask | 104 Ask | 112 Ask |
| 18" x 18" | 1250 | 88 52231 | 96 51615 | 104 Ask | 100 Ask | 108 Ask | 116 Ask |

Exclusive ADP Feature!
Includes both earthquake tabs & lances for compliance with all municipal codes

- Tabs can be folded over T-Bar
- Tabs can be screwed to T-Bar
- Tabs or lances can be wired to ceiling

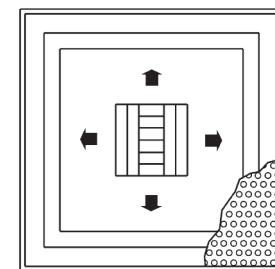

Square Neck
(4-Way Standard)

| Modifications | List Price |
|---|------------|
| Add for 1, 2, 2C or 3-Way blow patterns | 20 |

• White dots = Low demand items. Check availability before quoting.

APC3F

Flush screen for Standard Lay-in ceiling grids

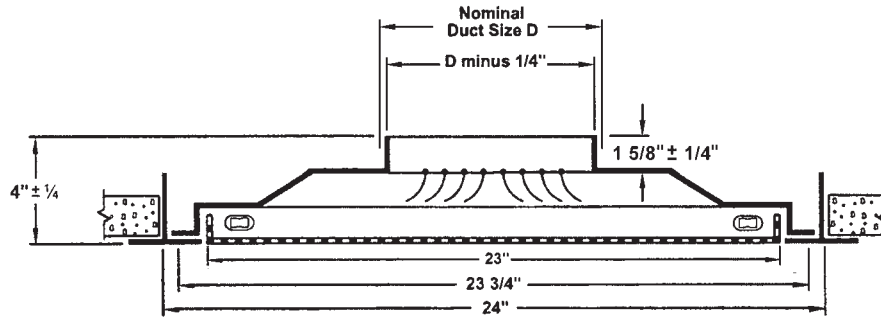

APC3N

Stepdown screen for Narrow-Tee/Bolt-Slot ceiling grids

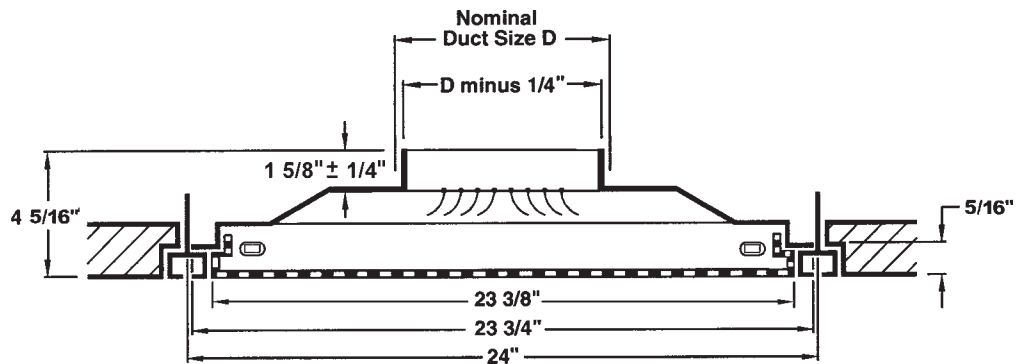

APC3D

Drop screen for Tegular ceiling grids

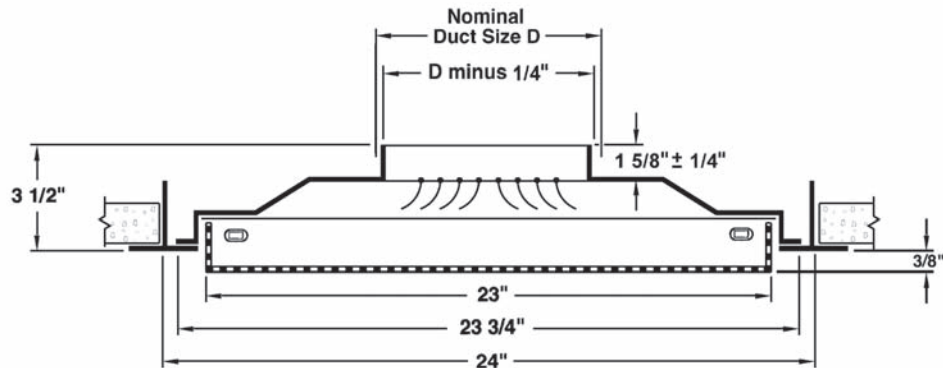

Other Available Blow Patterns

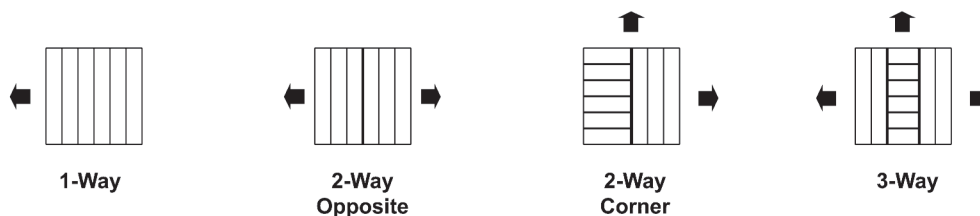

Related items

Matching Returns – Pages 11, 12
 Hard Ceiling Frames – Page 36
 Accessory Dampers – Pages 39, 40
 Neck Adapters – Pages 41, 42

APM3

Steel • Modular Core • Convertible Discharge Pattern

Features:

- Classic MAC Series diffuser, developed and introduced by ADP in 1960
- Round or square neck
- Removable cores are spring-loaded for easy blow pattern arrangement
- Maintains a horizontal flow pattern from maximum to minimum cfm in VAV systems
- 24" x 24" square lay-in ceiling module with removable screen
- Perforated face has industry standard 3/16" holes on 1/4" staggered centers
- Powder coated epoxy finish; white perf on black backpan, or white on white

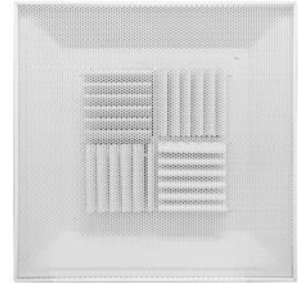

APM3

| Integral round neck sizes | | | | | | | |
|---------------------------|-----------------|-------------------|-------------------|-------------------|---------------------------|-------------------|-------------------|
| Duct Size | Max CFM @ NC 35 | All white | | | White with black interior | | |
| | | List Price APM3FW | List Price APM3NW | List Price APM3DW | List Price APM3FB | List Price APM3NB | List Price APM3DB |
| | | SKU | SKU | SKU | SKU | SKU | SKU |
| 6" | 170 | 86 52256 | 94 52284 | 102 • Ask | 98 • Ask | 106 52270 | 114 • Ask |
| 8" | 260 | 90 52258 | 98 52286 | 106 • Ask | 102 • Ask | 110 52272 | 118 • Ask |
| 10" | 380 | 94 52260 | 102 52288 | 110 • Ask | 106 • Ask | 114 52274 | 122 • Ask |
| 12" | 520 | 100 52262 | 108 52290 | 116 • Ask | 112 • Ask | 120 52276 | 128 • Ask |
| 14" | 680 | 110 52264 | 118 52292 | 116 • Ask | 122 • Ask | 130 52278 | 128 • Ask |
| 16" | 850 | 136 52266 | 144 52294 | 152 • Ask | 148 • Ask | 156 52280 | 164 • Ask |

Exclusive ADP Feature!
Integral round neck design eliminates the need for accessory adapters

• White dots = Low demand items. Check availability before quoting.
Note: APM diffusers are shipped with Modular Cores set for a 4-Way throw

| Integral square neck sizes | | | | | | | |
|----------------------------|-----------------|-------------------|-------------------|-------------------|---------------------------|-------------------|-------------------|
| Duct Size | Max CFM @ NC 35 | All white | | | White with black interior | | |
| | | List Price APM3FW | List Price APM3NW | List Price APM3DW | List Price APM3FB | List Price APM3NB | List Price APM3DB |
| | | SKU | SKU | SKU | SKU | SKU | SKU |
| 6" x 6" | 200 | 86 52227 | 94 52285 | 102 • Ask | 98 • Ask | 106 52271 | 114 • Ask |
| 8" x 8" | 330 | 90 52259 | 98 52287 | 106 • Ask | 102 • Ask | 110 52273 | 118 • Ask |
| 10" x 10" | 470 | 94 52261 | 102 52289 | 110 • Ask | 106 • Ask | 114 52275 | 122 • Ask |
| 12" x 12" | 640 | 100 52263 | 108 52291 | 116 • Ask | 112 • Ask | 120 52277 | 128 • Ask |
| 14" x 14" | 850 | 110 52265 | 118 52293 | 126 • Ask | 122 • Ask | 130 52279 | 138 • Ask |
| 16" x 16" | 1020 | 136 52267 | 144 52295 | 152 • Ask | 148 • Ask | 156 52281 | 164 • Ask |
| 18" x 18" | 1230 | 150 52268 | 158 Ask | 166 • Ask | 162 • Ask | 170 52282 | 178 • Ask |

Exclusive ADP Feature!
Includes both earthquake tabs & lances for compliance with all municipal codes
- Tabs can be folded over T-Bar
- Tabs can be screwed to T-Bar
- Tabs or lances can be wired to ceiling

• White dots = Low demand items. Check availability before quoting.
Note: APM diffusers are shipped with Modular Cores set for a 4-Way throw

APM3F

Flush screen for Standard Lay-in ceiling grids

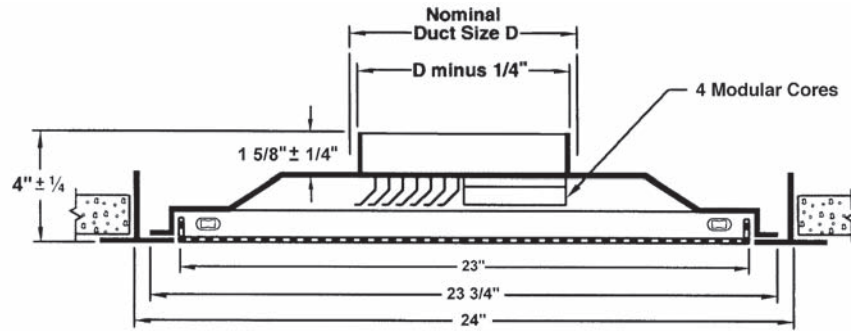

APM3N

Stepdown screen for Narrow-Tee/Bolt-Slot ceiling grids

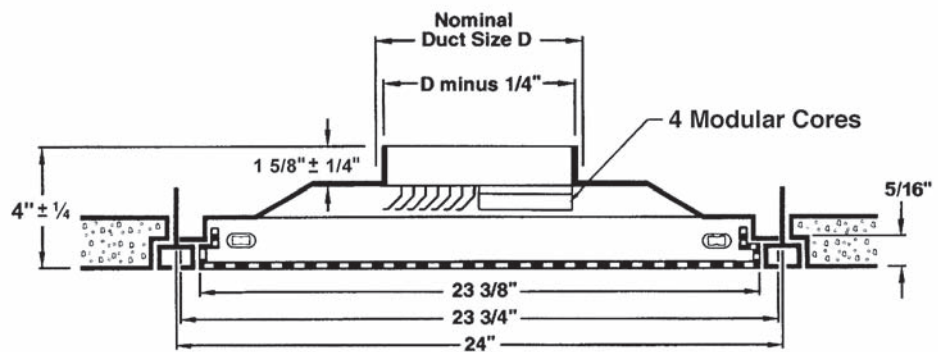

APM3D

Drop screen for Tegular ceiling grids

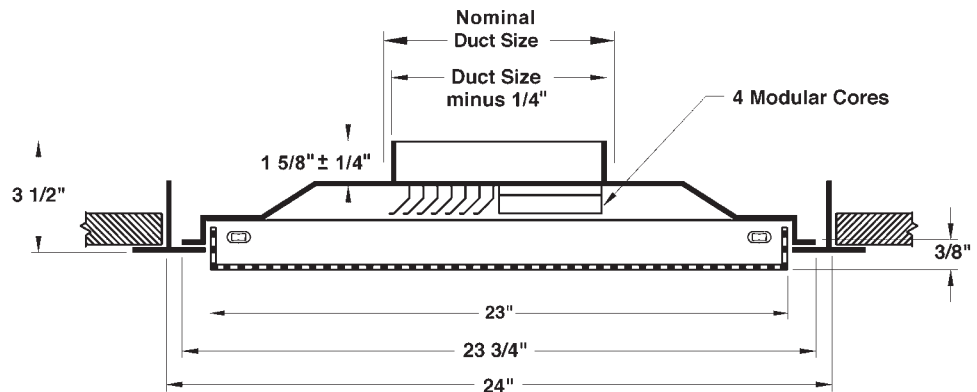

Modular Core Adjustments

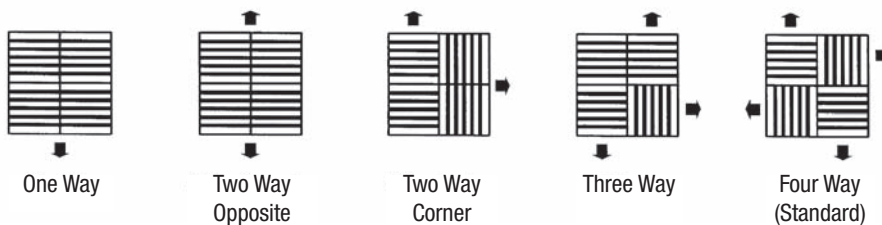

Related items

Matching Returns – Pages 11, 12
 Hard Ceiling Frames – Page 36
 Accessory Dampers – Pages 39, 40
 Neck Adapters – Pages 41, 42

APA3

Steel • Deflector Style • Adjustable Discharge Pattern

Features:

- Round or square neck
- 1, 2, 3 or 4-Way adjustable discharge pattern
- Discharge pattern is adjusted by dropping the perforated face and rotating the pattern controllers
- 24" x 24" square lay-in ceiling module with removable screen
- Perforated face has industry standard $\frac{3}{16}$ " holes on $\frac{1}{4}$ " staggered centers
- Powder coated finish; white perf on black backpan

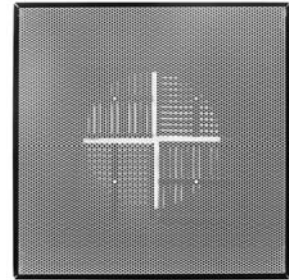

APA3

APA3F

Flush screen for Standard Lay-in ceiling grids

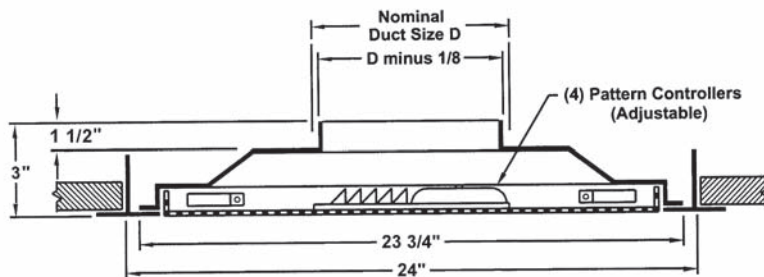

| Round Duct Size | Max CFM @ NC 35 | List Price APA3FB SKU | List Price APA3DB SKU |
|-----------------|-----------------|--------------------------|--------------------------|
| 6" | 200 | 68 51484 | 84 Ask |
| 8" | 300 | 68 51486 | 84 Ask |
| 10" | 400 | 68 51488 | 84 Ask |
| 12" | 540 | 68 51490 | 84 Ask |
| 14" | 650 | 68 51492 | 84 Ask |
| 16" | 840 | 68 Ask | 84 Ask |

• White dots = Low demand items.
Check availability before quoting.

Note: APA diffusers are shipped with pattern deflectors set for a 4-Way throw

APA3D

Drop screen for Tegular ceiling grids

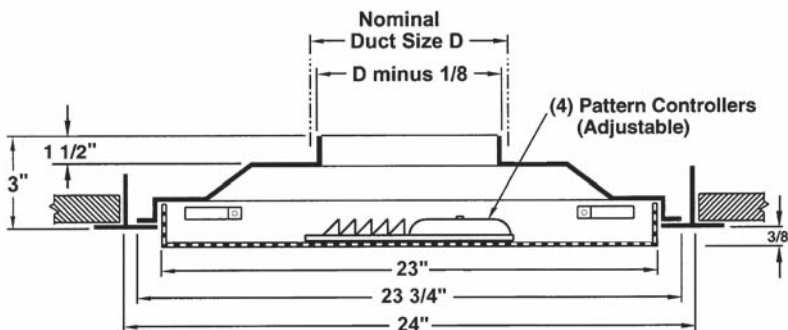

| Round Duct Size | Max CFM @ NC 35 | List Price APA3FB SKU | List Price APA3DB SKU |
|-----------------|-----------------|--------------------------|--------------------------|
| 6" x 6" | 140 | 76 51485 | 92 Ask |
| 8" x 8" | 350 | 76 51487 | 92 Ask |
| 10" x 10" | 480 | 76 51489 | 92 Ask |
| 12" x 12" | 620 | 76 51491 | 92 Ask |
| 15" x 15" | 800 | 92 51493 | 108 Ask |
| 18" x 18" | 1000 | 92 51495 | 108 Ask |

Note: APA diffusers are shipped with pattern deflectors set for a 4-Way throw

APS3

Steel • Rotatable Core • Clover Pattern

Features:

- Round or square neck
- Generates a high-induction air pattern for maximum throw
- Delivers a horizontal blanket of air that maintains a Coanda effect at varying air volumes
- Can be changed to either side-blow or corner-blow in the field
- 24" x 24" square lay-in ceiling module with removable screen
- Perforated face has industry standard 3/16" holes on 1/4" staggered centers
- Powder coated finish; white perf on black backpan, or white on white

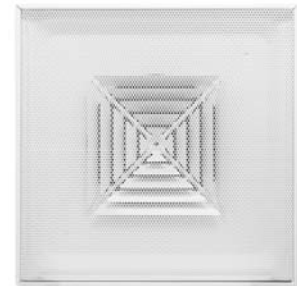

APS3

APS3F

Flush screen for Standard Lay-in ceiling grids

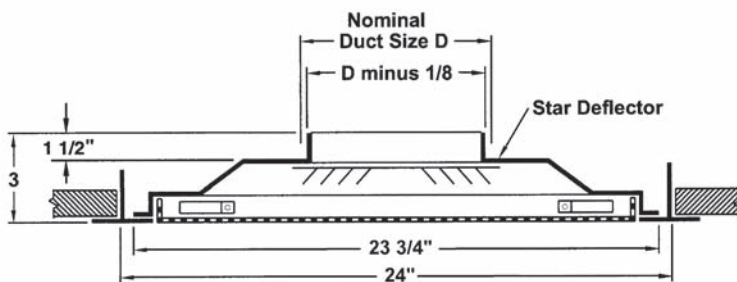

| Duct Size | Max CFM @ NC 35 | List Price APS3FW <small>SKU</small> | List Price APS3FB <small>SKU</small> | List Price APS3DW <small>SKU</small> | List Price APS3DB <small>SKU</small> |
|-----------|-----------------|---|---|---|---|
| 6" | 170 | 80 <small>51734</small> | 92 <small>51724</small> | 96 • <small>51714</small> | 108 • <small>51704</small> |
| 8" | 290 | 80 <small>51736</small> | 92 <small>51726</small> | 96 • <small>51716</small> | 108 • <small>51706</small> |
| 10" | 430 | 80 <small>51738</small> | 92 <small>51728</small> | 96 • <small>51718</small> | 108 • <small>51708</small> |
| 12" | 590 | 80 <small>51740</small> | 92 <small>51730</small> | 96 • <small>51720</small> | 108 • <small>51710</small> |
| 14" | 780 | 80 <small>51742</small> | 92 <small>51732</small> | 96 • <small>51722</small> | 108 • <small>51712</small> |
| 16" | 970 | 102 <small>51743</small> | 114 <small>51733</small> | 118 • <small>51723</small> | 130 • <small>51713</small> |
| 6"x6" | 220 | 98 • <small>51735</small> | 110 • <small>51725</small> | 114 • <small>51715</small> | 126 • <small>51705</small> |
| 8"x8" | 350 | 98 • <small>51737</small> | 110 • <small>51727</small> | 114 • <small>51717</small> | 126 • <small>51707</small> |
| 10"x10" | 530 | 98 • <small>51739</small> | 110 • <small>51729</small> | 114 • <small>51719</small> | 126 • <small>51709</small> |
| 12"x12" | 720 | 98 • <small>51741</small> | 110 • <small>51731</small> | 114 • <small>51721</small> | 126 • <small>51711</small> |

• White dots = Low demand items. Check availability before quoting.

APS3D

Drop screen for Tegular ceiling grids

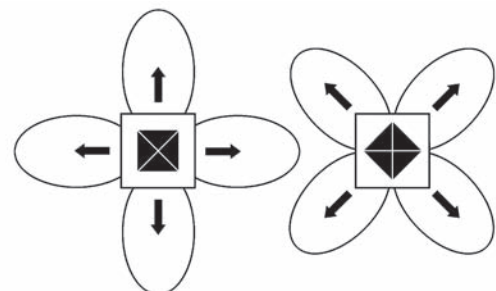
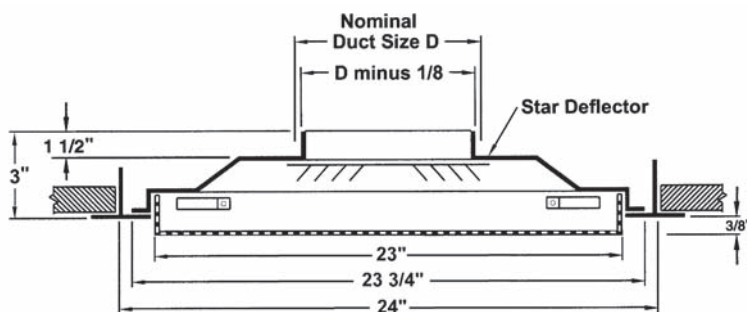

Standard blow patterns (on left) can be field adjusted to diagonal pattern (on right)

Related items

Matching Returns – Pages 11, 12
 Hard Ceiling Frames – Page 36
 Accessory Dampers – Pages 39, 40
 Neck Adapters – Pages 41, 42

APR3

Steel • Ducted

Features:

- Matching perforated return for APC, APM, APS and APA diffusers
- Round or square neck
- Inlet collar is approximately 1 5/8" deep for easy duct connection
- 24" x 24" square lay-in ceiling module with removable screen
- Perforated face has industry standard 3/16" holes on 1/4" staggered centers
- Powder coated epoxy finish; white perf on black backpan, or white on white

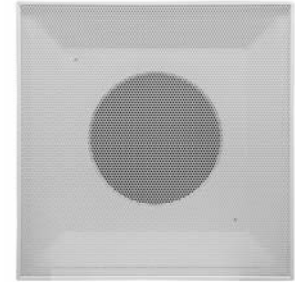

APR3

Exclusive ADP Feature!
Includes both earthquake tabs & lances for compliance with all municipal codes

- Tabs can be folded over T-Bar
- Tabs can be screwed to T-Bar
- Tabs or lances can be wired to ceiling

APR3F

Flush screen for Standard Lay-in ceiling grids

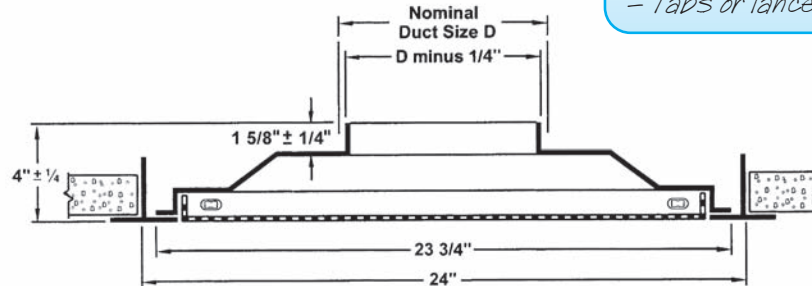

APR3N

Stepdown screen for Narrow-Tee/Bolt-Slot ceiling grids

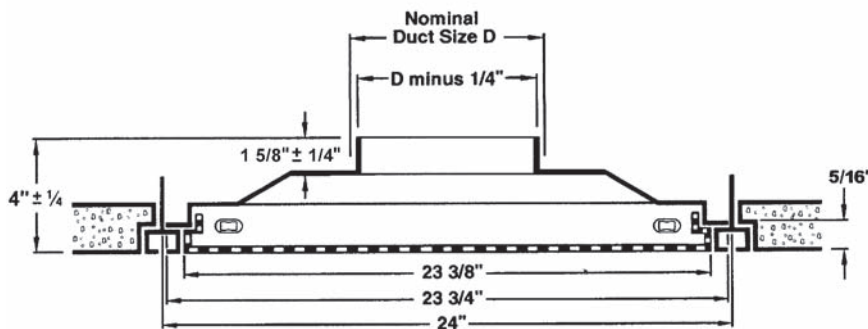

APR3D

Drop screen for Tegular ceiling grids

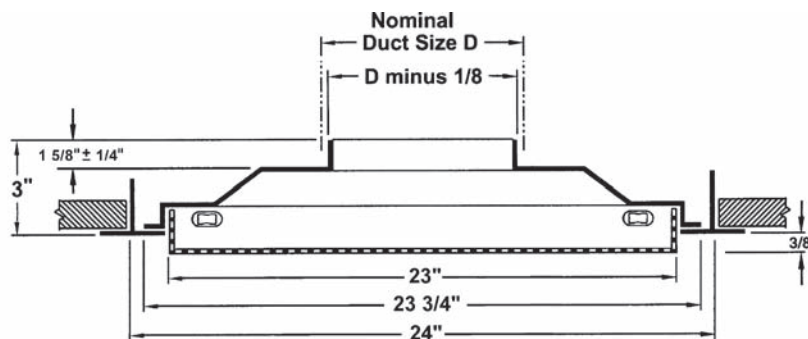

| Integral round neck sizes | | | | | | | | |
|---------------------------|------------------|-----------------|-------------------|-------------------|-------------------|-------------------------------|-------------------|-------------------|
| Duct Size | Ceiling MOD Size | Max CFM @ NC 35 | All white | | | All white with black interior | | |
| | | | List Price APR3FW | List Price APR3NW | List Price APR3DW | List Price APR3FB | List Price APR3NB | List Price APR3DB |
| | | | SKU | SKU | SKU | SKU | SKU | SKU |
| 6" | 24"x 24" | 200 | 54 52332 | 62 72364 | 70 Ask | 66 52315 | 74 72348 | 82 Ask |
| 8" | 24"x 24" | 300 | 54 52334 | 62 72366 | 70 Ask | 66 52317 | 74 72350 | 82 Ask |
| 10" | 24"x 24" | 450 | 54 52335 | 62 72368 | 70 Ask | 66 52319 | 74 72352 | 82 Ask |
| 12" | 24"x 24" | 600 | 54 52337 | 62 72370 | 70 Ask | 66 52321 | 74 72354 | 82 Ask |
| 14" | 24"x 24" | 800 | 54 52339 | 62 72372 | 70 Ask | 66 52323 | 74 72356 | 82 Ask |
| 16" | 24"x 24" | 1100 | 58 52341 | 66 72374 | 74 Ask | 70 52325 | 78 72358 | 86 Ask |
| 18" | 24"x 24" | 1250 | 58 52343 | 66 72376 | 74 Ask | 70 52327 | 78 72360 | 86 Ask |
| 20" | 24"x 24" | 1500 | 58 52345 | 66 72378 | 74 Ask | 70 52329 | 78 72362 | 86 Ask |

• White dots = Low demand items. Check availability before quoting.

| Integral square neck sizes | | | | | | | | |
|----------------------------|------------------|-----------------|-------------------|-------------------|-------------------|-------------------------------|-------------------|-------------------|
| Duct Size | Ceiling MOD Size | Max CFM @ NC 35 | All white | | | All white with black interior | | |
| | | | List Price APR3FW | List Price APR3NW | List Price APR3DW | List Price APR3FB | List Price APR3NB | List Price APR3DB |
| | | | SKU | SKU | SKU | SKU | SKU | SKU |
| 6" x 6" | 24"x 24" | 250 | 60 52333 | 68 72365 | 76 Ask | 72 52316 | 80 72349 | Ask |
| 8"x8" | 24"x 24" | 350 | 62 51786 | 70 72367 | 78 Ask | 74 52318 | 82 72351 | Ask |
| 10"x10" | 24"x 24" | 500 | 62 52336 | 70 72369 | 78 Ask | 74 52320 | 82 72353 | Ask |
| 12"x12" | 24"x 24" | 700 | 62 52338 | 70 72371 | 78 Ask | 74 52322 | 82 72355 | Ask |
| 14"x14" | 24"x 24" | 900 | 66 52340 | 74 72373 | 82 Ask | 78 52324 | 86 72357 | Ask |
| 16"x16" | 24"x 24" | 1200 | 66 52342 | 74 72375 | 82 Ask | 78 52326 | 86 72359 | Ask |
| 18"x18" | 24"x 24" | 1500 | 66 52344 | 74 72377 | 82 Ask | 78 52328 | 86 72361 | Ask |
| 22"x22" | 24"x 24" | 3000 | 62 52347 | 79 72379 | 78 Ask | 74 52321 | 82 72363 | Ask |
| 10" x 10" | 12" x 12" | 450 | 60 51469 | - | - | Ask | - | - |
| 22"x 10" | 24"x 12" | 1500 | 50 52346 | 58 Ask | 66 Ask | 62 52330 | 70 Ask | Ask |
| 46"x 22" | 48"x 24" | 6000 | 100 Ask | Ask | 116 Ask | 112 Ask | Ask | Ask |

• White dots = Low demand items. Check availability before quoting.

Related items

Hard Ceiling Frames – Page 36
Accessory Dampers – Pages 39, 40
Neck Adapters – Pages 41, 42

Perforated Return Screens – Lay-in



APX3

Steel • Non-ducted

Features:

- Economical, non-ducted perforated panels
- Perforated screens have industry standard 3/16" holes on 1/4" staggered centers
- White powder coated epoxy finish

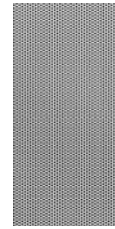

12" x 24"

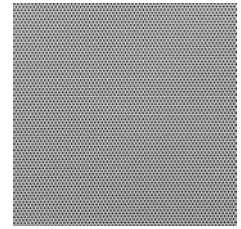

24" x 24"

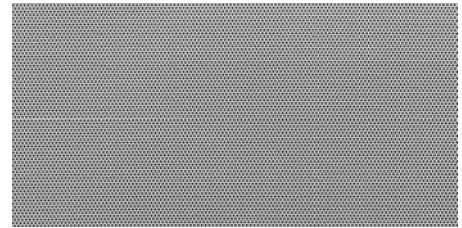

48" x 24"

APX3F

Flush screen for Standard Lay-in ceiling grids

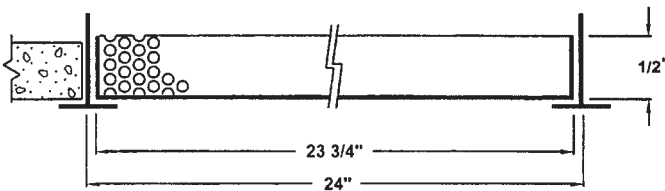

APX3N

Stepdown screen for Narrow-Tee/Bolt-Slot ceiling grids

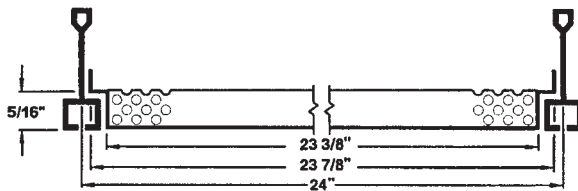

| Duct Size | Max CFM @ NC 35 | List Price APX3FW <small>SKU</small> | List Price APX3NW <small>SKU</small> | List Price APX3DW <small>SKU</small> |
|-----------|-----------------|---|---|---|
| 24"x12" | 1500 | 21 52393 | 30 52395 | 36 51744 |
| 24"x24" | 3000 | 26 52394 | 38 52396 | 52 51745 |
| 48"x24" | 6000 | 52 51748 | 78 52397 | - |

• White dots = Low demand items. Check availability before quoting.

APX3D

Drop screen for Tegular ceiling grids

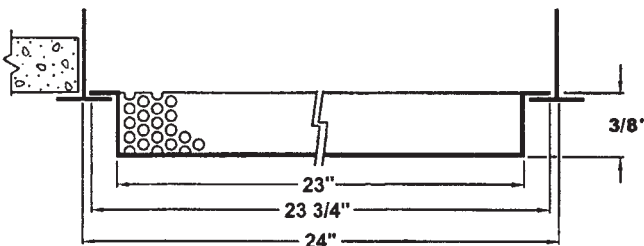

Exclusive ADP Feature!
We manufacture our own perforated panels and screens – no middle man allows us to pass the savings on to our customers

Related items

Neck Adapters & Cans – Pages 41, 42

APDBS/APDBU/APDBR

Features:

- All models accommodate 4” through 16” start collars (see below)
- All models for Lay-in T-Bar ceiling
- All models come with a black interior and a white perforated metal face

Model APDBS2424 Supply has four individually adjustable and removable deflectors

Model APDBU2424 Universal is both a 4-way supply and a return with a removable 6” round disc deflector

Model APDBR2424 Return has no deflectors

| Model | List Price SKU |
|------------|-------------------|
| APDBS 2424 | 66 • 73104 |
| APDBU 2424 | 54 • 73105 |
| APDBR 2424 | 62 • 73103 |

• White dots = Low demand items. Check availability before quoting.

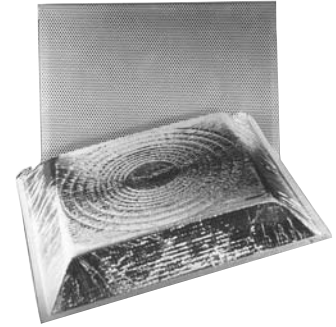

APDBS/APDBU/APDBR

APDBF/APMBF

Features:

- Three inch high steel frame
- Holds a 20” x 20” x 1” filter and accommodates a 4” through 20” start collar
- For Lay-in T-Bar ceilings
- Black interior and a white perforated metal face

| Model | Description | List Price SKU |
|-------------|-----------------|-------------------|
| APDBF 2424 | Fiberglass Back | 96 • 73102 |
| APMBF 2424 | Metal Back | 120 • 73307 |
| Poly Filter | 20”x 20”x 1” | 8 11414 |

• White dots = Low demand items. Check availability before quoting.

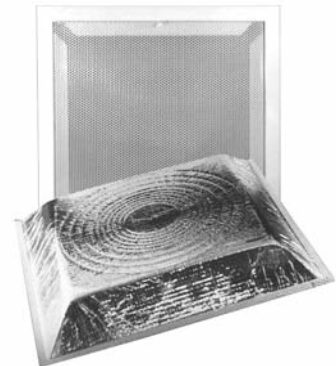

APDBF

SCG (Start Collars)

5” K.D., High Crimp – Dove Tail

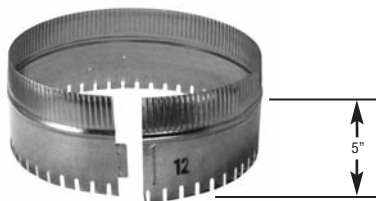

| Duct Size | List Price SKU |
|-----------|-------------------|
| 4” | 4 71292 |
| 5” | 4 71293 |
| 6” | 5 71294 |
| 7” | 6 71295 |
| 8” | 6 71296 |
| 9” | 7 71297 |

| Duct Size | List Price SKU |
|-----------|-------------------|
| 10” | 7 71298 |
| 12” | 9 71299 |
| 14” | 10 71300 |
| 16” | 11 71301 |
| 18” | 14 71302 |
| 20” | 14 71303 |

APM1 / APM5 / APC5

Steel • Modular or Curved Blade Cores

APM1 Features:

- Curved frame, no screw holes
- Modular Core design
- Four individually adjustable modular core sections for 1, 2, 3, or 4-Way blow pattern
- Square neck
- White powder coated epoxy finish

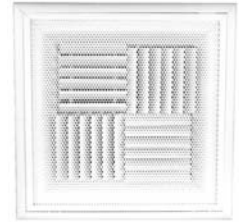
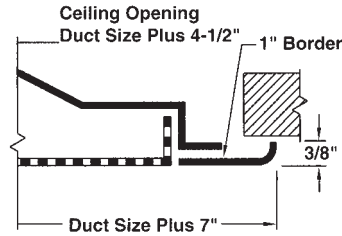

APM1

APM5 Features:

- Flat frame with screw holes
- Modular Core design
- Four individually adjustable modular core sections for 1, 2, 3, or 4-Way blow pattern
- Square neck
- Ceiling opening same as duct size
- White powder coated epoxy finish

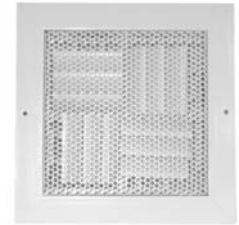
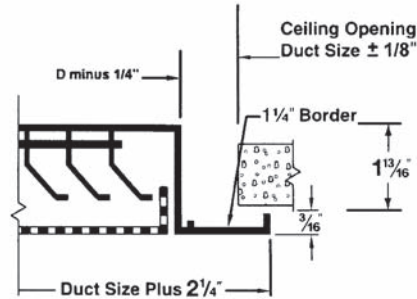

APM5

APC5 Features:

- Flat frame with screw holes
- Curved blade core
- Square neck
- Ceiling opening same as duct size
- 4-Way adjustable curved blade core
- White powder coated epoxy finish

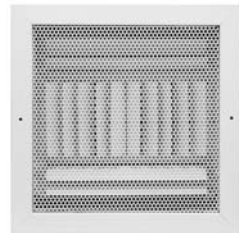
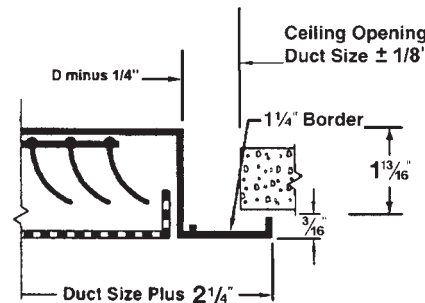

APC5

| Duct Size | Max CFM @ NC 35 | List Price APM1 SKU | Add OBDB Damper* SKU | List Price APM5 SKU | List Price APC5 SKU | Add OBDBS Damper* SKU |
|-----------|-----------------|------------------------|-------------------------|------------------------|------------------------|--------------------------|
| 6"x6" | 200 | 120 51656 | 12 56754 | 100 52305 | 100 52247 | 12 56893 |
| 8"x8" | 330 | 124 51657 | 16 56757 | 108 52306 | 108 52248 | 16 56894 |
| 10"x10" | 500 | 132 51658 | 16 56762 | 112 52307 | 112 52249 | 16 56895 |
| 12"x12" | 700 | 144 51659 | 20 56767 | 120 52308 | 120 52250 | 20 56896 |
| 14"x14" | 810 | 152 51660 | 24 56773 | 140 52309 | 140 52251 | 24 56897 |
| 16"x16" | 950 | 196 51661 | 28 56781 | 164 52310 | 164 52252 | 28 56898 |
| 18"x18" | 1250 | 228 51662 | 32 56789 | 192 52311 | 192 52253 | 32 56899 |
| 20"x20" | 3200 | - | - | 216 52312 | 216 52254 | 36 56900 |
| 24"x24" | 1700 | - | - | 260 52314 | 260 52255 | 60 56901 |

Exclusive ADP Feature!
Ceiling opening same as neck size on APM5 & APC5.
Never go back for a re-cut!

Note: APM diffusers are shipped with Modular Cores set for a 4-Way throw

* Dampers ship loose

• White dots = Low demand items. Check availability before quoting.

Related items

Matching Returns – Page 16

APR1 / APR5

Steel • Ducted

APR1 Features:

- Matching return for the APM1
- Curved frame, no screw holes
- Square neck
- White powder coated epoxy finish

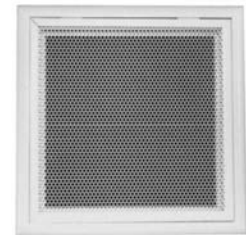
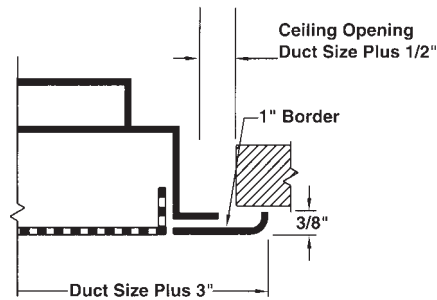

APR1

APR5 Features:

- Matching return for the APM5 and APC5
- Flat frame with screw holes
- Square neck
- White powder coated epoxy finish

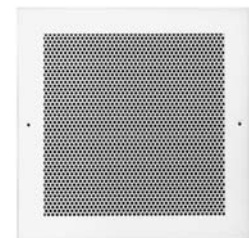
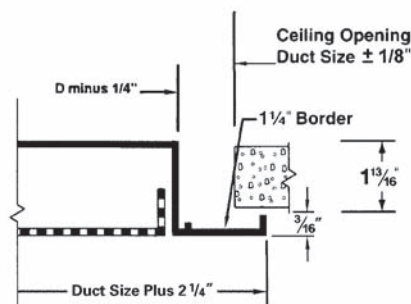

APR5

| Duct Size | Max CFM @ NC 35 | List Price APR1 <i>SKU</i> | Add OBDB Damper* <i>SKU</i> | List Price APR5 <i>SKU</i> | Add OBDBS Damper* <i>SKU</i> |
|-----------|-----------------|-------------------------------|--------------------------------|-------------------------------|---------------------------------|
| 6"x6" | 270 | 72 51692 | 12 56754 | 34 52382 | 12 56893 |
| 8"x8" | 520 | 76 51693 | 16 56757 | 38 52383 | 16 56894 |
| 10"x10" | 820 | 82 51694 | 16 56762 | 46 52384 | 16 56895 |
| 12"x12" | 1200 | 86 51695 | 20 56767 | 50 52385 | 20 56896 |
| 14"x14" | 1500 | 92 51696 | 24 56773 | 58 52386 | 24 56897 |
| 16"x16" | 1940 | 118 51698 | 28 56781 | 68 52387 | 28 56898 |
| 18"x18" | 2400 | 138 51699 | 32 56789 | 80 52388 | 32 56899 |
| 20"x20" | 2700 | 154 51700 | 36 56798 | 84 52389 | 36 56900 |
| 22"x22" | 3200 | 174 51702 | 40 56807 | 92 52390 | 40 56926 |
| 24"x24" | 3800 | – | – | 112 52392 | 60 56901 |
| 24"x12" | 2100 | – | – | 76 52391 | 32 56927 |

* Dampers ship loose

Related items

Neck Adapters – Pages 41, 42
Ceiling Boxes – Page 41

Perforated Diffusers – Concealed Spline



APM4

Steel • Modular Core Supply

Features:

- Classic MAC Series diffuser, developed and introduced by ADP in 1960
- Rotating cam-lock for easy fastening to spline tee
- Square neck with OBD attached
- Four individually adjustable modular core sections for 1, 2, 3, or 4-Way blow pattern
- 24" x 24" ceiling module can be installed after ceiling is hung
- White powder coated epoxy finish

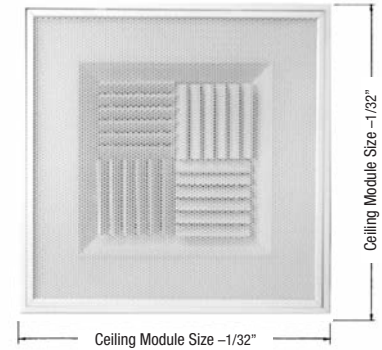

APM4

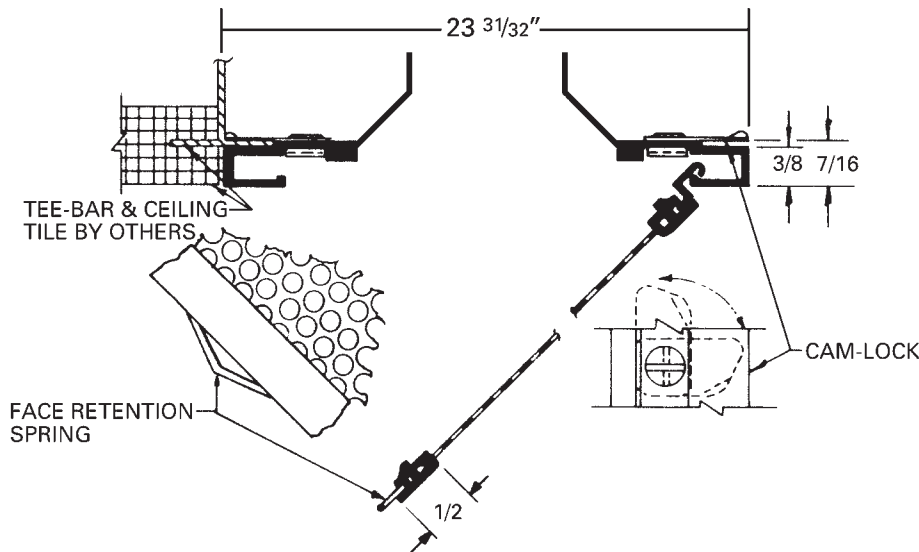

| Duct Size | Max CFM @ NC 35 | List Price APM4 with OBD <small>SKU</small> |
|-----------|-----------------|--|
| 6" x 6" | 200 | 146 • 52298 |
| 8" x 8" | 330 | 164 • 52299 |
| 10" x 10" | 500 | 180 • 52300 |
| 12" x 12" | 700 | 200 • 52301 |
| 14" x 14" | 810 | 228 • 52302 |
| 16" x 16" | 950 | 256 • 52303 |
| 18" x 18" | 1250 | 308 • 52304 |

• White dots = Low demand items.
Check availability before quoting.

Note: APM diffusers are shipped with Modular Cores set for a 4-Way throw

Exclusive ADP Feature!
Cam-Lock design allows installation and removal without disassembling ceiling – no need to coordinate with ceiling contractor

APR4

Steel • Ducted Return

Features:

- Matching return
- Rotating cam-lock for easy fastening to spline tee
- 24" x 12" and 24" x 24" ceiling module
- White powder coated epoxy finish

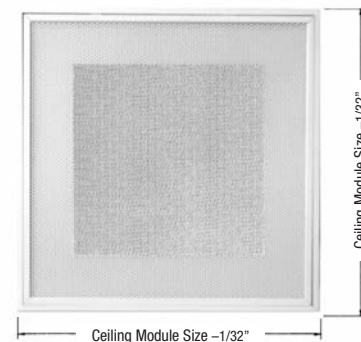

APR4

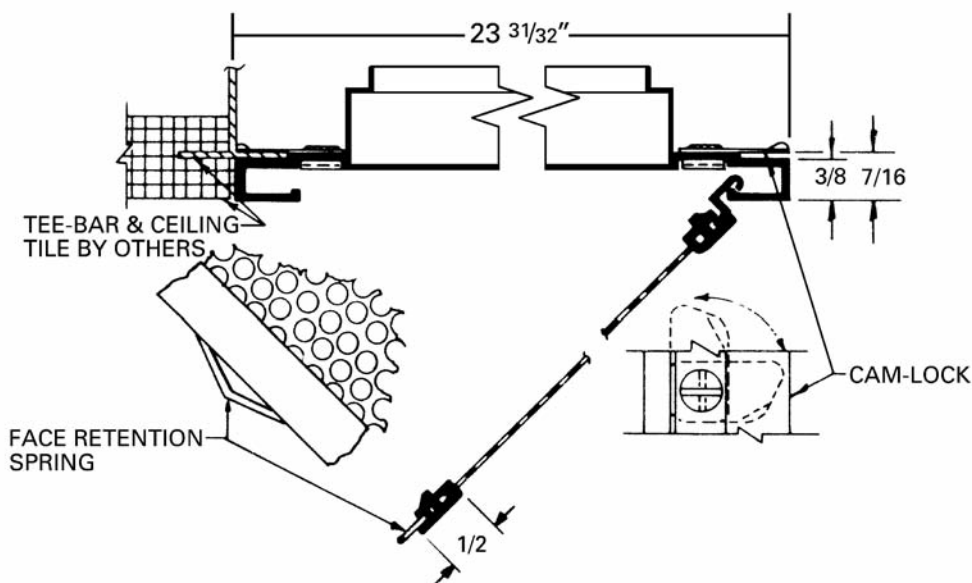

Exclusive ADP Feature!
 Cam-Lock design allows installation and removal without disassembling ceiling – no need to coordinate with ceiling contractor

| Duct Size | Max CFM @ NC 35 | List Price APR4 | Add ODBS Damper* |
|-----------|-----------------|-----------------|------------------|
| | | SKU | SKU |
| 22" x 10" | 1700 | 116 • 52380 | 28 • 56928 |
| 22" x 22" | 3200 | 172 • 52381 | 40 • 56926 |

• White dots = Low demand items. Check availability before quoting.

* Dampers ship loose on returns

Related items

Neck Adapters – Pages 41, 42

AC3

Steel or Aluminum • High Performance

Features:

- Integral round neck design
- High volume 360° air discharge pattern
- Attractive contoured cone design with smooth, clean surfaces
- Cones are one piece, die-stamped with no corner joints
- Excellent for variable air volume applications
- Three cones are standard, a fourth center cone option is available
- White powder coated epoxy finish



AC3

AC3 (12"x12" Lay-in)

For Standard Lay-in ceiling grids

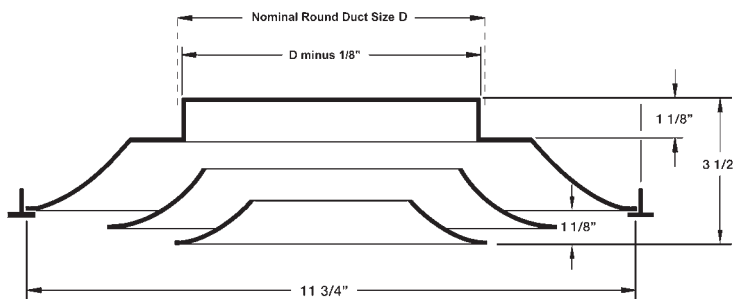

| Duct Size | Module Size | Max CFM @ NC 35 | List Price AC3 Steel |
|-----------|-------------|-----------------|----------------------|
| 6" | 12" x 12" | 200 | 60 51779 |
| 8" | 12" x 12" | 330 | 60 51781 |

White dots = Low demand items. Check availability before quoting.

AC3 (24"x24" Lay-in)

Universal Frame design for Standard and Narrow-Tee/Bolt-Slot grids

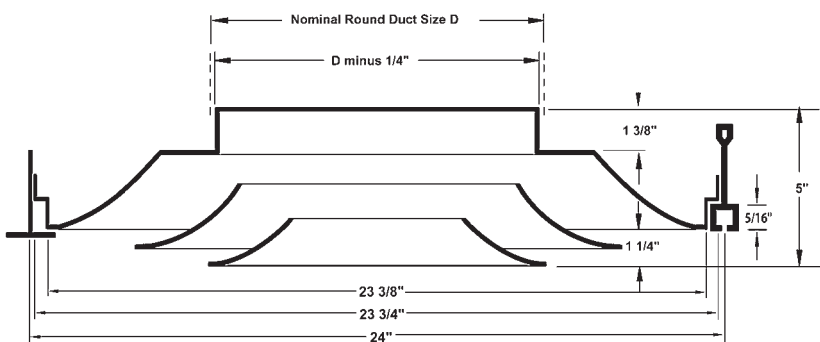

| Duct Size | Module Size | Max CFM @ NC 35 | List Price AC3 Steel | List Price AC3 Alum. |
|---|-------------|-----------------|----------------------|----------------------|
| 6" | 24" x 24" | 300 | 72 52148 | • |
| 8" | 24" x 24" | 460 | 72 52149 | • |
| 10" | 24" x 24" | 650 | 72 52150 | • |
| 12" | 24" x 24" | 800 | 72 52151 | • |
| 14" | 24" x 24" | 1070 | 72 52152 | • |
| 15" | 24" x 24" | 1190 | 72 52153 | • |
| Field attachable center (fourth) cone – fits all sizes (ships separately for easy installation) | | | | • |

White dots = Low demand items. Check availability before quoting.

Note: Please call for Aluminum price and sku.

*Exclusive ADP Feature!
Universal frame design fits both
Standard and Narrow-Tee Grids!*

A03

Steel or Aluminum • Horizontal Discharge

Features:

- Integral round neck design
- Low noise and pressure drop
- Architecturally pleasing center panel produces a 360° horizontal air discharge pattern
- Panel can be removed from the backpan for easy access to optional damper
- Attractive contoured backpan design with smooth, clean surfaces
- White powder coated epoxy finish

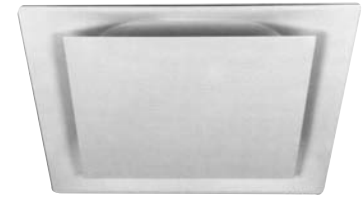

A03

A03 (12"x12" Lay-in)

For Standard Lay-in ceiling grids

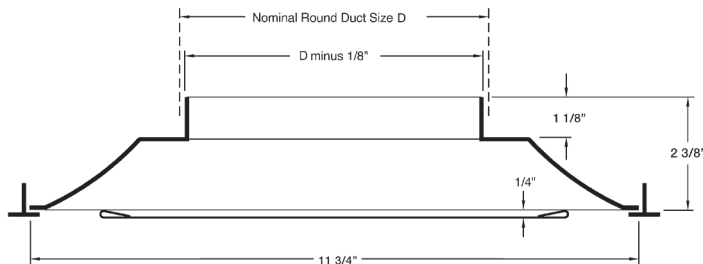

| Duct Size | Module Size | Max CFM @ NC 35 | List Price A03 Steel SKU |
|-----------|-------------|-----------------|-----------------------------|
| 6" | 12" x 12" | 250 | 64 • 51435 |
| 8" | 12" x 12" | 440 | 64 • 51437 |

• White dots = Low demand items. Check availability before quoting.

A03 (24"x24" Lay-in)

Universal Frame design for Standard and Narrow-Tee/Bolt-Slot grids

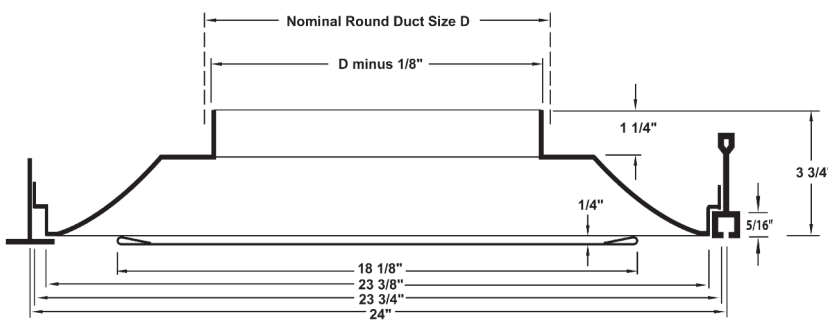

Exclusive ADP Feature!
Universal frame design fits both Standard and Narrow-Tee Grids!

Exclusive ADP Feature!
Snap-in panel design reduces damage from shipping & handling, also reduces freight cost

| Duct Size | Module Size | Max CFM @ NC 35 | List Price A03 Steel SKU | List Price A03 Alum. SKU |
|--------------------------|-------------|-----------------|-----------------------------|-----------------------------|
| 6" | 24" x 24" | 275 | 84 • 52181 | • |
| 8" | 24" x 24" | 460 | 84 • 52182 | • |
| 10" | 24" x 24" | 600 | 84 • 52183 | • |
| 12" | 24" x 24" | 800 | 84 • 52184 | • |
| 14" | 24" x 24" | 1000 | 84 • 52185 | • |
| 15" | 24" x 24" | 1200 | 84 • 52186 | • |
| Directional Blow Baffles | | | | 8 • 51433 |

• White dots = Low demand items. Check availability before quoting.

Note: Please call for Aluminum price and sku.

Related items

Hard Ceiling Frames – Page 36
Accessory Dampers – Pages 39, 40

AM5 / AM6

Steel • Convertible Discharge Pattern

Common Features:

- Classic MAC Series diffuser, developed and introduced by ADP in 1960
- Removable cores are spring-loaded for easy blow pattern arrangement
- Square neck
- Fits OBDBS damper
- White powder coated epoxy finish



AM5



AM6

| Duct Size | Max CFM @ NC 35 | List Price | |
|-----------|-----------------|--------------|--------------|
| | | AM5 SKU | AM6 SKU |
| 6"x6" | 275 | 54 52163 | 54 52172 |
| 8"x8" | 400 | 60 52164 | 60 52173 |
| 10"x10" | 600 | 70 52165 | 70 52174 |
| 12"x12" | 800 | 88 52166 | 88 52175 |
| 14"x14" | 1000 | 98 52167 | 98 52176 |
| 16"x16" | 1200 | 110 52168 | 110 52177 |
| 18"x18" | 1400 | 122 52169 | 122 52178 |
| 20"x20" | 1600 | 172 52170 | 172 52179 |
| 24"x24" | 2000 | 186 52171 | 186 52180 |

Note: AM diffusers are shipped with Modular Cores set for a 4-Way throw

AM5 Features:

- Flat frame design with screw holes
- Ceiling opening same as duct size
- Fits OBDBS Damper (inside neck mount)

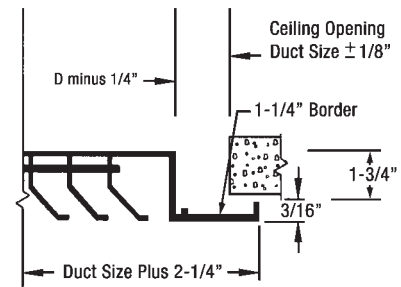

AM5 (Surface Mount, Flat Frame)

Exclusive ADP Feature!
Ceiling opening same size as duct size. Never go back for a re-cut!

AM6 Features:

- Beveled drop frame design, no screw holes
- Ceiling opening same as duct size
- Fits OBDBS Damper (outside neck mount)

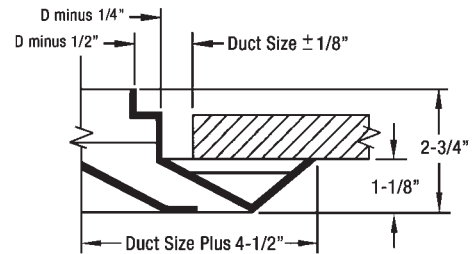

AM6 (Surface Mount, Beveled Frame)

Modular Core Adjustments

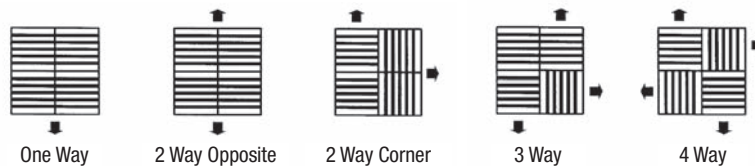

Related items

Accessory Dampers – Pages 39, 40
Neck Adapters – Pages 41, 42
Ceiling Boxes – Page 41

AM3

Steel • Convertible Discharge Pattern

Features:

- Classic MAC Series diffuser, developed and introduced by ADP in 1960
- Removable cores are spring-loaded for easy blow pattern arrangement
- 24" x 24" Lay-in filler panel
- Exclusive Universal Frame design fits Standard and Narrow-Tee Grids
- Square neck
- Fits OBDBS Damper
- White powder coated epoxy finish



AM3

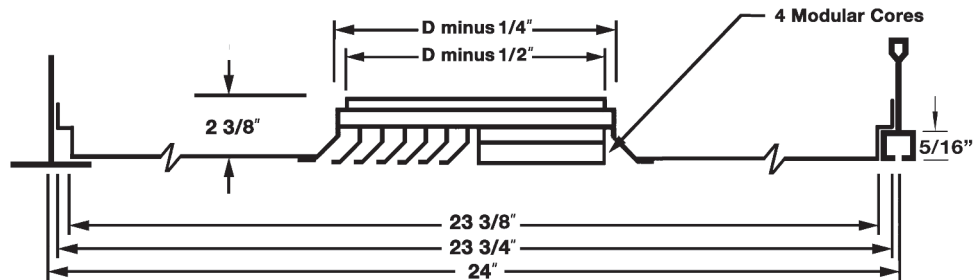

Modular Core Adjustments

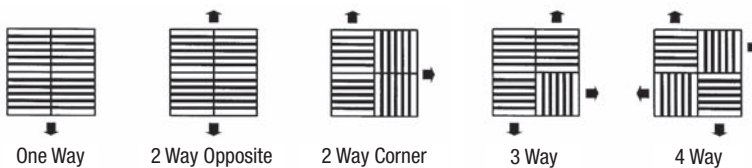

Exclusive ADP Feature!
 Universal frame design fits both
 Standard and Narrow-Tee Grids!

| Duct Size | Max CFM @ NC 35 | List Price AM3 Lay-in SKU |
|-----------|-----------------|------------------------------|
| 6" x 6" | 275 | 94 52154 |
| 8" x 8" | 400 | 100 52155 |
| 10" x 10" | 600 | 108 52156 |
| 12" x 12" | 800 | 124 52157 |
| 14" x 14" | 1000 | 132 52158 |
| 16" x 16" | 1200 | 154 52159 |
| 18" x 18" | 1400 | 172 52160 |
| 20" x 20" | 1600 | 208 52161 |
| 22" x 22" | 1800 | 256 52162 |

• White dots = Low demand items. Check availability before quoting.

Note: AM diffusers are shipped with Modular Cores set for a 4-Way throw

Related items

Hard Ceiling Frames – Page 36
 Accessory Dampers – Pages 39, 40
 Neck Adapters – Pages 41, 42

Louvered Face Ceiling Diffusers – Surface Mount



AL1 / AL6

Steel or Aluminum • Removable Core

Common Features:

- Louvered face design
- Square neck
- Core is removable from diffuser face
- Directional high capacity diffuser maintains horizontal blow pattern
- Excellent for variable volume applications
- Aluminum version is MRI compatible – no ferrous parts
- Fits OBDBL damper
- White powder coated epoxy finish



AL1



AL6

| Duct Size | Max CFM @ NC 35 | Steel 4-Way | | Aluminum 4-Way | |
|-----------|-----------------|-------------------------------|-------------------------------|-------------------------------|-------------------------------|
| | | List Price AL1S <i>SKU</i> | List Price AL6S <i>SKU</i> | List Price AL1A <i>SKU</i> | List Price AL6A <i>SKU</i> |
| 6"x6" | 225 | | | 36 56818 | 36 56827 |
| 9" x 9" | 450 | | | 52 56821 | 52 56828 |
| 12"x12" | 800 | | | 68 56822 | 68 56829 |
| 15"x15" | 1150 | | | 84 56823 | 84 56830 |
| 18"x18" | 1500 | | | 104 56824 | 104 56831 |
| 21"x21" | 2000 | | | 128 • 56825 | 128 • 56832 |
| 24"x24" | 2600 | | | 152 • 56826 | 152 • 56833 |

• White dots = Low demand items. Check availability before quoting.

Note 1: Please call for Steel pricing and skus.

Note 2: See page 25 for odd blow patterns

AL1 Features:

- Surface Mount
- Flat frame with screw holes
- Fits OBDBL damper

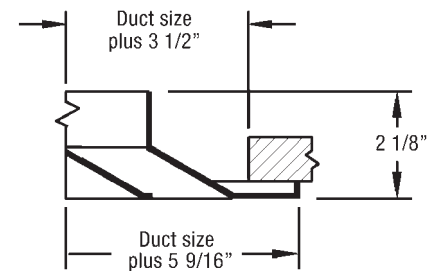

AL6 Features:

- Surface Mount
- Beveled drop frame
- Fits OBDBL damper

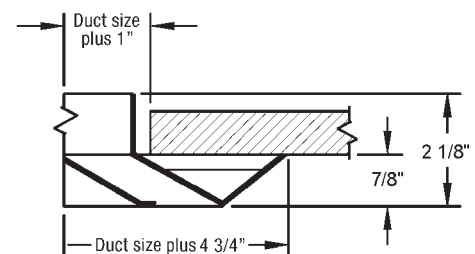

Pricing on this page is for diffusers with a 4-Way blow pattern. See page 25 for other blow patterns.

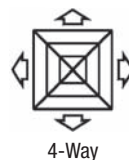

Related items

Accessory Dampers – Pages 39, 40
Neck Adapters – Pages 41, 42
Ceiling Boxes – Page 41

AL3

Aluminum Diffuser Core • Steel or Aluminum Panel

Features:

- Louvered face design
- Square neck
- Core is removable from diffuser face
- Directional high capacity diffuser maintains horizontal blow pattern
- Excellent for variable volume applications
- 24" x 24" Lay-in filler panel
- Exclusive Universal Frame design fits Standard and Narrow-Tee Grids
- Fits OBDBL damper
- White powder coated epoxy finish
- Aluminum panel version is MRI compatible – no ferrous parts



AL3

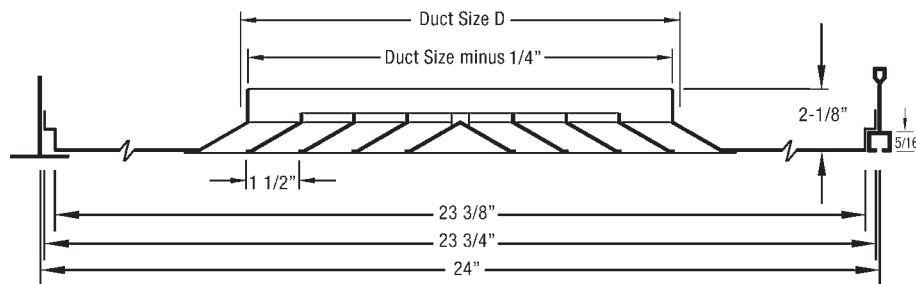

Exclusive ADP Feature!
 Universal frame design fits both
 Standard and Narrow-Tee Grids!

Pricing on this page is for diffusers with a 4-Way blow pattern. See page 25 for other blow patterns.

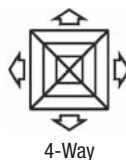

| Duct Size | Max CFM @ NC 35 | Steel Panel 4-Way | Alum. Panel 4-Way |
|-----------|-----------------|------------------------|------------------------|
| | | List Price AL3S SKU | List Price AL3A SKU |
| 6" x 6" | 225 | 76 56953 | • |
| 9" x 9" | 450 | 84 56954 | • |
| 12" x 12" | 800 | 96 56955 | • |
| 15" x 15" | 1150 | 104 56956 | • |
| 18" x 18" | 1500 | 120 56957 | • |
| 21" x 21" | 2000 | 230 Ask | • |

• White dots = Low demand items. Check availability before quoting.

Note 1: AL3S not available until 4Q11

Note 2: Please call for Aluminum panel pricing and skus

Note 3: See page 25 for odd blow patterns

Related items

Accessory Dampers – Pages 39, 40
 Neck Adapters – Pages 41, 42
 Ceiling Boxes – Page 41

Louvered Face Ceiling Diffusers – Cores Only



ALXA

Steel or Aluminum • Odd blow patterns

Common Features:

- Louvered face design
- Cores fit AL1, AL6 and AL3 diffuser frames
- White powder coated epoxy finish

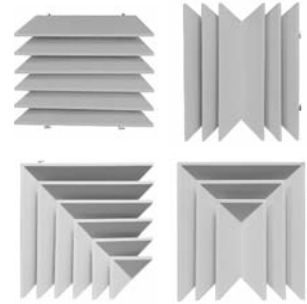

ALXA Cores

EXCHANGE PRICING: Use the table below for ordering an AL diffuser with cores other than 4-Way. Pricing includes credit for the 4-Way core removed.

| Diffuser Size | Steel Cores | | | | Aluminum Cores | | | |
|---------------|------------------|---------------------------|-------------------------|------------------|------------------|---------------------------|-------------------------|------------------|
| | List Price 1-Way | List Price 2-Way Opposite | List Price 2-Way Corner | List Price 3-Way | List Price 1-Way | List Price 2-Way Opposite | List Price 2-Way Corner | List Price 3-Way |
| | SKU | SKU | SKU | SKU | SKU | SKU | SKU | SKU |
| 6"x6" | | | | | 12 56819 | 12 56840 | 12 56851 | 12 56860 |
| 9" x 9" | | | | | 12 56834 | 12 56925 | 12 56852 | 12 56861 |
| 12"x12" | | | | | 12 56835 | 12 56842 | 12 56853 | 12 56862 |
| 15"x15" | | | | | 12 56836 | 12 56843 | 12 56854 | 12 56863 |
| 18"x18" | | | | | 12 56837 | 12 56844 | 12 56855 | 12 56864 |
| 21"x21" | | | | | 12 • 56838 | 12 • 56845 | 12 • 56856 | 12 • 56865 |
| 24"x24" | | | | | 12 • 56839 | 12 • 56850 | 12 • 56857 | 12 • 56866 |

• White dots = Low demand items. Check availability before quoting.

Note 1: Large orders may require extra time for core exchanges. Please call to check 2-Day availability before quoting.

Note 2: Please call for Steel pricing and skus.

Available blow patterns

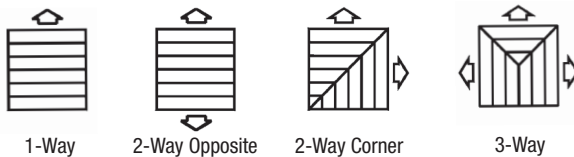

CB Series

Steel • Adjustable Blades

Features:

- Square neck with OBD attached
- Adjustable curved blades in a fixed 1, 2, 3 or 4-Way discharge pattern
- Louvers are individually adjustable from the face of the diffuser. The louvers regulate the air volume as well as the angle of discharge
- Designed for high sidewall, low sidewall, and ceiling installations
- Type 5 frame with screw holes
- Opposed blade damper is galvanized steel
- White powder coated epoxy finish



CB Series
(CB4 Shown)

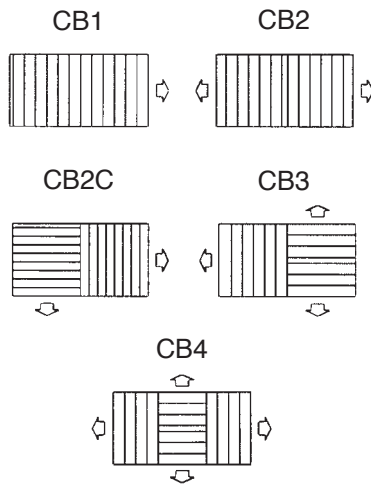

| Duct Size | Max CFM @ NC 35 | List Price CB1 | List Price CB2 | List Price CB2C | List Price CB3 | List Price CB4 |
|-----------|-----------------|----------------|----------------|-----------------|----------------|----------------|
| | | SKU | SKU | SKU | SKU | SKU |
| 6"x6" | 160 | 60 51000 | 60 51005 | 60 51010 | 60 51015 | 60 51020 |
| 8"x8" | 260 | 64 51001 | 64 51006 | 64 51011 | 64 51016 | 64 51021 |
| 10"x10" | 410 | 76 51002 | 76 51007 | 76 51012 | 76 51017 | 76 51022 |
| 12"x12" | 560 | 92 51003 | 92 51008 | 92 51013 | 92 51018 | 92 51023 |
| 14"x14" | 750 | 108 51004 | 108 51009 | 108 51014 | 108 51019 | 108 51024 |
| 16"x16" | 880 | - | - | - | - | 128 51025 |
| 18"x18" | 1170 | - | - | - | - | 152 51026 |
| 20"x20" | 1440 | - | - | - | - | 180 51027 |
| 22"x22" | 1630 | - | - | - | - | 208 51028 |
| 24"x24" | 1820 | - | - | - | - | 240 51029 |

Model CB

Note: All models include galvanized OBD

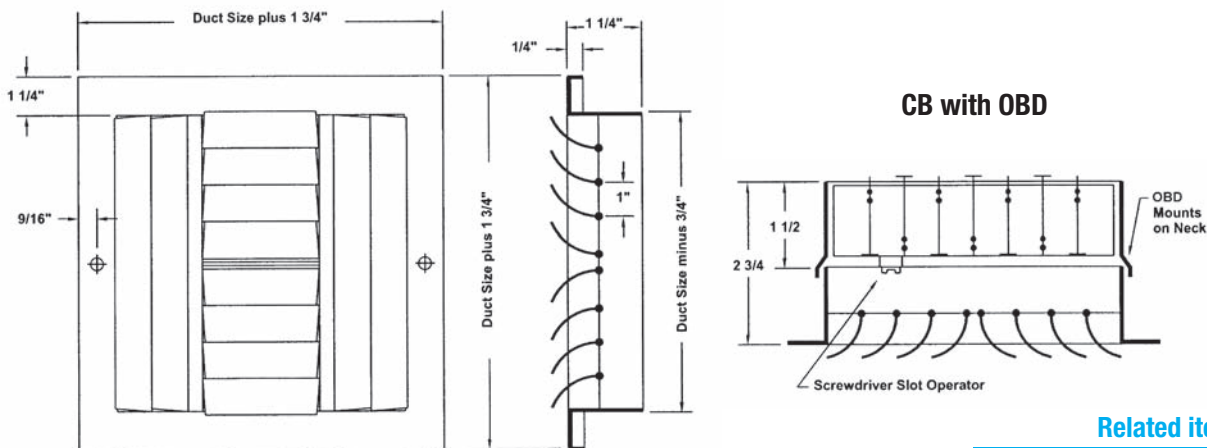

Related items

Neck Adapters – Pages 41, 42
Ceiling Boxes – Page 41

AR2

Steel • Two position

Features:

- Uniform, 360° degree discharge pattern
- 2-Position adjustment for heating and cooling seasons
- To adjust the diffuser, remove the two center cones as a unit and reposition the screws
- Spring lock allows easy removal and replacement of the 2 inner cones
- Retainer cables are provided on sizes 12 and larger to allow the inner cones to hang while adjusting the diffuser
- White powder coated epoxy finish



AR2

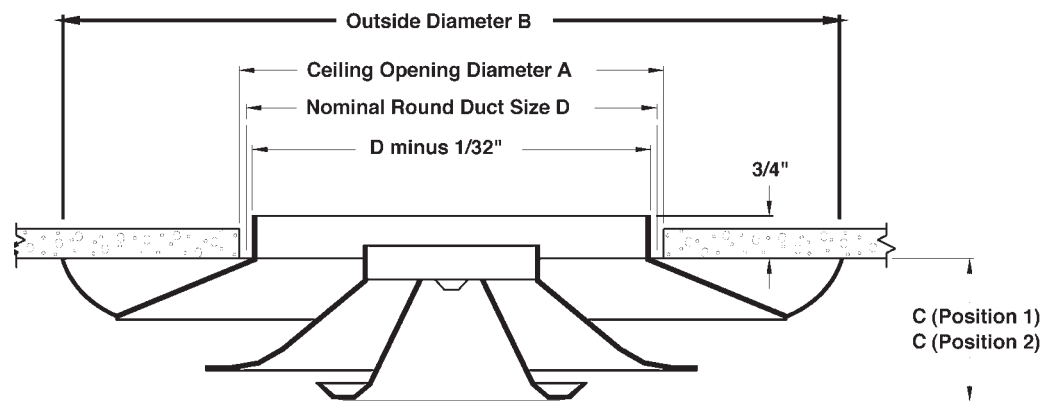

AR2
2-Position Adjustment

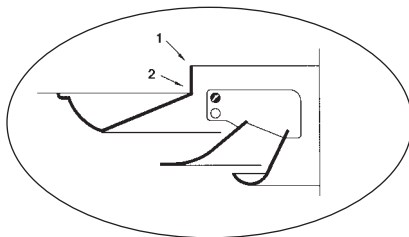

| Nominal Round Duct Size D | A | B | C (Pos. 1) | C (Pos. 2) |
|---------------------------|--------|--------|------------|------------|
| 6 | 6 1/2 | 11 1/8 | 1 3/4 | 1 1/8 |
| 8 | 8 1/2 | 14 3/4 | 2 1/8 | 1 1/2 |
| 10 | 10 1/2 | 18 1/4 | 2 7/8 | 2 1/8 |
| 12 | 12 1/2 | 22 | 3 1/8 | 2 3/8 |
| 14 | 14 1/2 | 26 | 3 3/8 | 2 5/8 |
| 16 | 16 1/2 | 29 | 4 | 3 1/4 |
| 18 | 18 1/2 | 32 1/2 | 4 3/4 | 3 7/8 |
| 20 | 20 1/2 | 36 | 5 7/8 | 4 7/8 |
| 24 | 24 1/2 | 43 1/4 | 7 3/4 | 6 5/8 |

| Duct Size | Max CFM @ NC 35 | List Price AR2 SKU |
|-----------|-----------------|-----------------------|
| 6" | 220 | 138 51769 |
| 8" | 360 | 146 51770 |
| 10" | 540 | 160 51771 |
| 12" | 770 | 180 51772 |
| 14" | 960 | 206 51773 |
| 16" | 1260 | 252 51774 |
| 18" | 1550 | 304 51775 |
| 20" | 1900 | 330 51776 |
| 24" | 2600 | 384 51777 |

White dots = Low demand items. Check availability before quoting.

AR3

Steel • Adjustable

Features:

- Uniform, 360° degree discharge pattern
- Horizontal-to-vertical adjustment for heating and cooling seasons
- To adjust the diffuser, rotate center cone
- Excellent performance in variable air volume applications
- Spring lock allows easy removal and replacement of the 3 inner cones.
- Retainer cables are provided on sizes 12 and larger to allow the inner cones to hang while adjusting the diffuser
- White powder coated epoxy finish



AR3

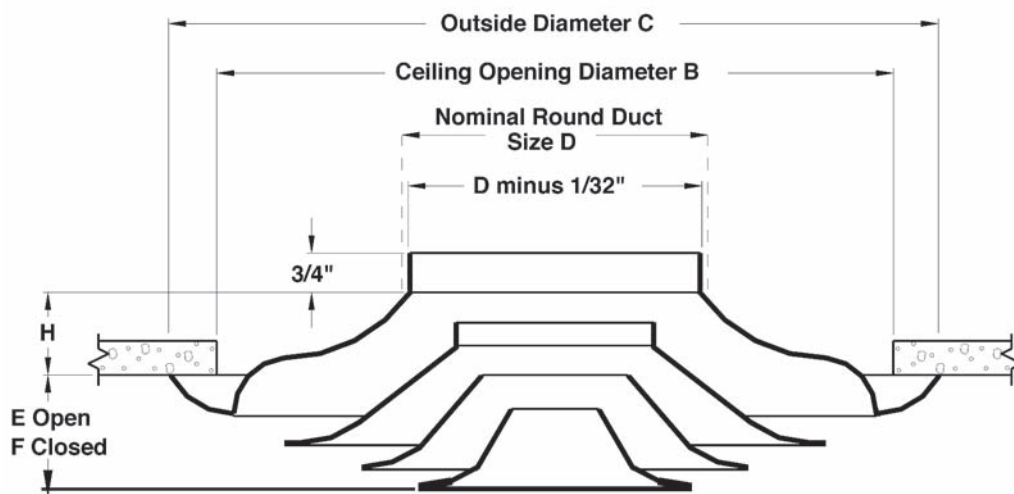

| Duct Size | Max CFM @ NC 35 | List Price AR3 <small>SKU</small> |
|-----------|-----------------|--------------------------------------|
| 6" | 200 | 160 <small>51805</small> |
| 8" | 340 | 192 <small>51806</small> |
| 10" | 500 | 220 <small>51807</small> |
| 12" | 705 | 290 <small>51808</small> |
| 14" | 950 | 366 <small>51809</small> |
| 16" | 1200 | 484 <small>51810</small> |
| 18" | 1500 | 520 <small>51811</small> |
| 20" | 1850 | 588 <small>51812</small> |
| 24" | 2500 | 694 <small>51813</small> |

• White dots = Low demand items.
Check availability before quoting.

| Nominal Round Duct Size D | B | C | E | F | H |
|---------------------------|----|------|-------|-------|--------|
| 6 | 12 | 13½ | 1 4/9 | 11/16 | 1 5/8 |
| 8 | 16 | 18 | 1 4/5 | 7/8 | 2 1/8 |
| 10 | 20 | 22½ | 2 1/4 | 1 1/8 | 2 5/8 |
| 12 | 24 | 27 | 2 2/3 | 1 1/4 | 3 1/4 |
| 14 | 28 | 31½ | 3 1/8 | 1 1/5 | 3 3/4 |
| 16 | 31 | 36 | 3 1/3 | 1 1/3 | 4 1/4 |
| 18 | 36 | 40 ½ | 3 3/4 | 1 1/2 | 4 7/8 |
| 20 | 40 | 45 | 4 1/8 | 1 5/8 | 5 3/8 |
| 24 | 48 | 54 | 4 7/8 | 1 7/8 | 6 1/12 |

Continuous Adjustment (Rotating)

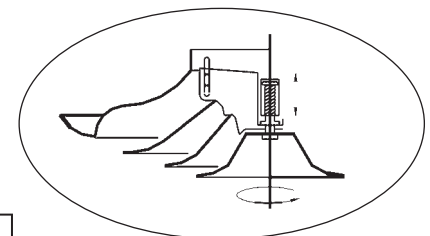

Related items

Accessory Dampers – Pages 39, 40
Neck Adapters – Pages 41, 42

Double Deflection Supply Register



DDVA

Aluminum with Steel OBD • Double Deflection • Vertical front blades

Features:

- Surface mounting with screw holes
- Vertical front and horizontal rear blades on $\frac{3}{4}$ " centers, individually adjustable for desired airflow direction
- Heavy-duty opposed blade damper with screwdriver adjustment through face of register
- Register frame and blades constructed of aluminum with white powder coated epoxy finish
- OBD damper is constructed of heavy-gauge steel with flat black powder coated epoxy finish

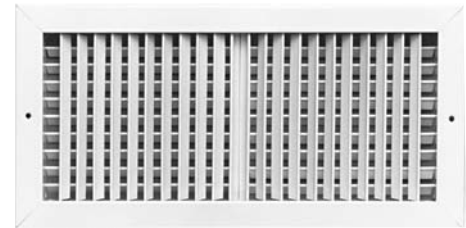

DDVA

Exclusive ADP Feature!

FREE Blade Adjustment Tool included with every DDVA order!

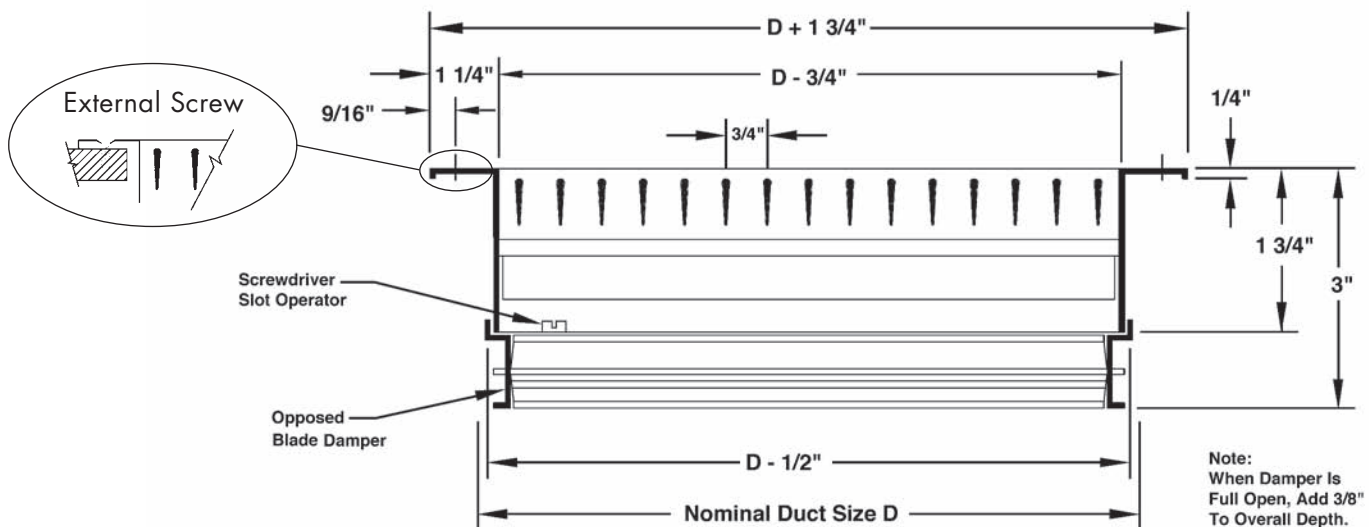

Exclusive ADP Feature!

INDUSTRY'S BEST OBD

- Flat black eliminates reflection
- Heavy-duty construction
- Smooth, non-binding operation
- Attached with electro-plated Z-clips that never rust



Double Deflection Supply Register (continued)



| Duct Size | DDVA List Price SKU | Duct Size | DDVA List Price SKU | Duct Size | DDVA List Price SKU | Duct Size | DDVA List Price SKU | Duct Size | DDVA List Price SKU | Duct Size | DDVA List Price SKU |
|-----------|------------------------|-----------|------------------------|-----------|------------------------|-----------|------------------------|-----------|------------------------|-----------|------------------------|
| 06"x 04" | 36 56169 | 16"x 08" | 72 56191 | 22"x 04" | 68 56213 | 26"x 06" | 96 56235 | 30"x 08" | 120 56261 | 32"x 32" | 340 56287 |
| 06"x 06" | 40 56170 | 16"x 10" | 80 56192 | 22"x 06" | 80 56214 | 26"x 08" | 108 56236 | 30"x 10" | 136 56262 | 34"x 06" | 116 56289 |
| 08"x 04" | 40 56171 | 16"x 12" | 88 56193 | 22"x 08" | 88 56215 | 26"x 10" | 120 56237 | 30"x 12" | 148 56263 | 34"x 08" | 132 56290 |
| 08"x 06" | 44 56172 | 16"x 14" | 96 56194 | 22"x 10" | 100 56216 | 26"x 12" | 136 56238 | 30"x 14" | 164 56264 | 34"x 10" | 148 56291 |
| 08"x 08" | 48 56173 | 16"x 16" | 104 56195 | 22"x 12" | 112 56217 | 26"x 14" | 148 56239 | 30"x 16" | 180 56265 | 34"x 12" | 164 56292 |
| 10"x 04" | 44 56174 | 18"x 04" | 60 56196 | 22"x 14" | 120 56218 | 26"x 16" | 160 56240 | 30"x 18" | 196 56266 | 34"x 14" | 180 56293 |
| 10"x 06" | 48 56175 | 18"x 06" | 68 56197 | 22"x 16" | 132 56219 | 26"x 18" | 176 56241 | 30"x 20" | 212 56267 | 34"x 16" | 196 56294 |
| 10"x 08" | 56 56176 | 18"x 08" | 76 56198 | 22"x 18" | 144 56220 | 26"x 20" | 192 56242 | 30"x 22" | 224 56268 | 34"x 18" | 212 56295 |
| 10"x 10" | 60 56177 | 18"x 10" | 88 56199 | 22"x 20" | 156 56221 | 28"x 04" | 88 56246 | 30"x 24" | 240 56269 | 34"x 20" | 232 56296 |
| 12"x 04" | 48 56178 | 18"x 12" | 96 56200 | 22"x 22" | 164 56222 | 28"x 06" | 100 56247 | 30"x 26" | 280 56270 | 34"x 22" | 248 56297 |
| 12"x 06" | 52 56179 | 18"x 14" | 104 56201 | 24"x 04" | 72 56223 | 28"x 08" | 116 56248 | 30"x 30" | 308 56272 | 34"x 24" | 264 56298 |
| 12"x 08" | 60 56180 | 18"x 16" | 116 56202 | 24"x 06" | 84 56224 | 28"x 10" | 128 56249 | 32"x 06" | 112 56274 | 36"x 06" | 120 56305 |
| 12"x 10" | 68 56181 | 18"x 18" | 124 56203 | 24"x 08" | 96 56225 | 28"x 12" | 140 56250 | 32"x 08" | 124 56275 | 36"x 08" | 136 56306 |
| 12"x 12" | 72 56182 | 20"x 04" | 64 56204 | 24"x 10" | 108 56226 | 28"x 14" | 156 56251 | 32"x 10" | 140 56276 | 36"x 10" | 152 56307 |
| 14"x 04" | 52 56183 | 20"x 06" | 72 56205 | 24"x 12" | 120 56227 | 28"x 16" | 172 56252 | 32"x 12" | 156 56277 | 36"x 12" | 172 56308 |
| 14"x 06" | 60 56184 | 20"x 08" | 84 56206 | 24"x 14" | 128 56228 | 28"x 18" | 184 56253 | 32"x 14" | 172 56278 | 36"x 14" | 188 56309 |
| 14"x 08" | 68 56185 | 20"x 10" | 92 56207 | 24"x 16" | 140 56229 | 28"x 20" | 200 56254 | 32"x 16" | 188 56279 | 36"x 16" | 204 56310 |
| 14"x 10" | 72 56186 | 20"x 12" | 104 56208 | 24"x 18" | 152 56230 | 28"x 22" | 216 56255 | 32"x 18" | 204 56280 | 36"x 18" | 224 56311 |
| 14"x 12" | 80 56187 | 20"x 14" | 112 56209 | 24"x 20" | 180 56231 | 28"x 24" | 228 56256 | 32"x 20" | 220 56281 | 36"x 20" | 240 56312 |
| 14"x 14" | 88 56188 | 20"x 16" | 124 56210 | 24"x 22" | 192 56232 | 28"x 28" | 280 56258 | 32"x 22" | 236 56282 | 36"x 24" | 276 56314 |
| 16"x 04" | 56 56189 | 20"x 18" | 132 56211 | 24"x 24" | 208 56233 | 30"x 04" | 92 56259 | 32"x 24" | 252 56283 | 36"x 30" | 356 56317 |
| 16"x 06" | 64 56190 | 20"x 20" | 144 56212 | 26"x 04" | 84 56234 | 30"x 06" | 104 56260 | 32"x 26" | 292 56284 | - | - |

Exclusive ADP Feature!
 Same Day, Next Day and Standard 2-Day shipping options on more than 100 DDVA sizes.
 No one delivers like ADP!

Fixed Bar Return Grille – Surface Mount



FBH1A

Aluminum • Horizontal blades

Features:

- Fixed blades run long dimension on 3/4" centers (35° deflection)
- Surface mount with screw holes except sizes indicated by NSH
- MRI compatible – no ferrous parts
- Fits OBDB damper
- White powder coated epoxy finish

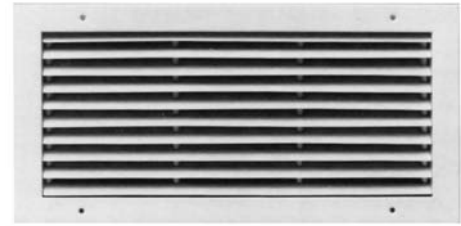

FBH1A

Exclusive ADP Feature!
 Same Day, Next Day and Standard 2-Day shipping options on more than 200 FBH1A sizes.
 No one delivers like ADP!

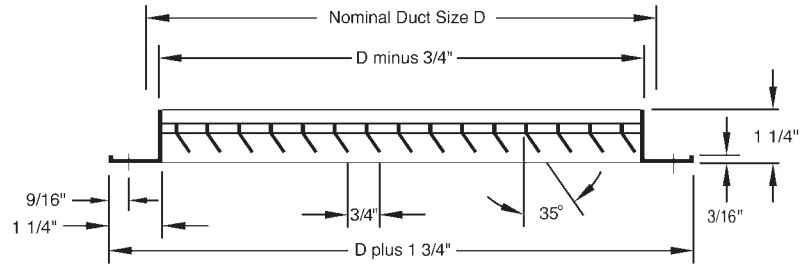

| Duct Size | FBH1A List Price SKU | Duct Size | FBH1A List Price SKU | Duct Size | FBH1A List Price SKU | Duct Size | FBH1A List Price SKU | Duct Size | FBH1A List Price SKU | Duct Size | FBH1A List Price SKU |
|------------------|-------------------------|-----------|-------------------------|-----------|-------------------------|------------------|-------------------------|-----------|-------------------------|-----------|-------------------------|
| 06" x 04" | 16 56346 | 14" x 06" | 24 56362 | 18" x 12" | 44 56378 | 22" x 10" NSH | 44 56394 | 24" x 20" | 76 56410 | 28" x 06" | 40 56426 |
| 06" x 06" | 16 56347 | 14" x 08" | 28 56363 | 18" x 14" | 48 56379 | 22" x 12" | 48 56395 | 24" x 22" | 84 56411 | 28" x 08" | 44 56427 |
| 08" x 04" | 16 56348 | 14" x 10" | 32 56364 | 18" x 16" | 52 56380 | 22" x 14" | 56 56396 | 24" x 24" | 88 56412 | 28" x 10" | 52 56428 |
| 08" x 06" | 20 56349 | 14" x 12" | 36 56365 | 18" x 18" | 56 56381 | 22" x 16" | 60 56397 | 26" x 04" | 32 56413 | 28" x 12" | 60 56429 |
| 08" x 08" | 24 56350 | 14" x 14" | 40 56366 | 20" x 04" | 24 56382 | 22" x 18" | 68 56398 | 26" x 06" | 36 56414 | 28" x 14" | 64 56430 |
| 10" x 04" | 20 56351 | 16" x 04" | 24 56367 | 20" x 06" | 32 56383 | 22" x 20" | 72 56399 | 26" x 08" | 44 56415 | 28" x 16" | 72 56431 |
| 10" x 06" | 20 56352 | 16" x 06" | 28 56368 | 20" x 08" | 36 56384 | 22" x 22" | 72 56400 | 26" x 10" | 48 56416 | 28" x 18" | 80 56432 |
| 10" x 08" | 24 56353 | 16" x 08" | 32 56369 | 20" x 10" | 40 56385 | 22" x 22" NSH | 72 56401 | 26" x 12" | 56 56417 | 28" x 20" | 88 56433 |
| 10" x 10" | 28 56354 | 16" x 10" | 36 56370 | 20" x 12" | 48 56386 | 24" x 04" | 28 56402 | 26" x 14" | 64 56418 | 28" x 22" | 92 56434 |
| 10" x 10" NSH | 28 56355 | 16" x 12" | 40 56371 | 20" x 14" | 52 56387 | 24" x 06" | 36 56403 | 26" x 16" | 68 56419 | 28" x 24" | 100 56435 |
| 12" x 04" | 20 56356 | 16" x 14" | 44 56372 | 20" x 16" | 56 56388 | 24" x 08" | 40 56404 | 26" x 18" | 76 56420 | 28" x 28" | 112 56437 |
| 12" x 06" | 24 56357 | 16" x 16" | 48 56373 | 20" x 18" | 60 56389 | 24" x 10" | 48 56405 | 26" x 20" | 80 56421 | 30" x 04" | 32 56438 |
| 12" x 08" | 28 56358 | 18" x 04" | 24 56374 | 20" x 20" | 68 56390 | 24" x 12" | 52 56406 | 26" x 22" | 88 56422 | 30" x 06" | 40 56439 |
| 12" x 10" | 32 56359 | 18" x 06" | 28 56375 | 22" x 04" | 28 56391 | 24" x 14" | 60 56407 | 26" x 24" | 96 56423 | 30" x 08" | 48 56440 |
| 12" x 12" | 32 56360 | 18" x 08" | 32 56376 | 22" x 06" | 32 56392 | 24" x 16" | 64 56408 | 26" x 26" | 100 56424 | 30" x 10" | 56 56441 |
| 14" x 04" | 20 56361 | 18" x 10" | 40 56377 | 22" x 08" | 40 56393 | 24" x 18" | 72 56409 | 28" x 04" | 32 56425 | 30" x 12" | 64 56442 |

Fixed Bar Return Grille – Surface Mount (continued)



| Duct Size | FBH1A List Price SKU | Duct Size | FBH1A List Price SKU | Duct Size | FBH1A List Price SKU | Duct Size | FBH1A List Price SKU | Duct Size | FBH1A List Price SKU | Duct Size | FBH1A List Price SKU |
|-----------|-------------------------|-----------|-------------------------|-----------|-------------------------|-----------|-------------------------|-----------------|-------------------------|-----------|-------------------------|
| 30"x 14" | 68 56443 | 34"x 12" | 68 56471 | 36"x 36" | 172 56499 | 40"x 20" | 116 56526 | 42"x 36" | 196 56553 | 46"x 30" | 180 56591 |
| 30"x 16" | 76 56444 | 34"x 14" | 76 56472 | 38"x 04" | 40 56500 | 40"x 22" | 124 56527 | 42"x 42" | 232 56556 | 48"x 04" | 48 56600 |
| 30"x 18" | 84 56445 | 34"x 16" | 84 56473 | 38"x 06" | 48 56501 | 40"x 24" | 132 56528 | 44"x 04" | 44 56557 | 48"x 06" | 60 56601 |
| 30"x 20" | 92 56446 | 34"x 18" | 92 56474 | 38"x 08" | 56 56502 | 40"x 26" | 144 56529 | 44"x 06" | 56 56558 | 48"x 08" | 68 56602 |
| 30"x 22" | 100 56447 | 34"x 20" | 100 56475 | 38"x 10" | 68 56503 | 40"x 28" | 152 56530 | 44"x 08" | 64 56559 | 48"x 10" | 80 56603 |
| 30"x 24" | 104 56448 | 34"x 22" | 108 56476 | 38"x 12" | 76 56504 | 40"x 30" | 160 56531 | 44"x 10" | 76 56560 | 48"x 12" | 92 56604 |
| 30"x 26" | 112 56449 | 34"x 24" | 116 56477 | 38"x 14" | 84 56505 | 40"x 32" | 168 56532 | 44"x 12" | 84 56561 | 48"x 14" | 100 56605 |
| 30"x 30" | 128 56451 | 34"x 26" | 124 56478 | 38"x 16" | 92 56506 | 40"x 34" | 180 56533 | 44"x 14" | 96 56562 | 48"x 16" | 112 56606 |
| 32"x 04" | 36 56452 | 34"x 28" | 132 56479 | 38"x 18" | 100 56507 | 40"x 36" | 188 56534 | 44"x 16" | 104 56563 | 48"x 18" | 124 56607 |
| 32"x 06" | 44 56453 | 34"x 30" | 140 56480 | 38"x 20" | 108 56508 | 40"x 40" | 216 56536 | 44"x 18" | 116 56564 | 48"x 20" | 132 56608 |
| 32"x 08" | 52 56454 | 34"x 34" | 156 56482 | 38"x 22" | 120 56509 | 42"x 04" | 44 56537 | 44"x 20" | 124 56565 | 48"x 22" | 144 56609 |
| 32"x 10" | 56 56455 | 36"x 04" | 40 56483 | 38"x 24" | 128 56510 | 42"x 06" | 52 56538 | 44"x 22" | 136 56566 | 48"x 24" | 156 56610 |
| 32"x 12" | 64 56456 | 36"x 06" | 48 56484 | 38"x 26" | 136 56511 | 42"x 08" | 64 56539 | 44"x 44" | 252 56577 | 48"x 26" | 168 56611 |
| 32"x 14" | 72 56457 | 36"x 08" | 56 56485 | 38"x 28" | 144 56512 | 42"x 10" | 72 56540 | 46"x 04" | 48 56578 | 48"x 28" | 176 56612 |
| 32"x 16" | 80 56458 | 36"x 10" | 64 56486 | 38"x 30" | 152 56513 | 42"x 12" | 80 56541 | 46"x 06" | 56 56579 | 48"x 30" | 188 56613 |
| 32"x 18" | 88 56459 | 36"x 12" | 72 56487 | 38"x 32" | 164 56514 | 42"x 14" | 92 56542 | 46"x 08" | 68 56580 | 48"x 32" | 200 56614 |
| 32"x 20" | 96 56460 | 36"x 14" | 80 56488 | 38"x 34" | 172 56515 | 42"x 16" | 100 56543 | 46"x 10" | 76 56581 | 48"x 36" | 220 56616 |
| 32"x 22" | 104 56461 | 36"x 16" | 88 56489 | 38"x 38" | 196 56517 | 42"x 18" | 108 56544 | 46"x 12" | 84 56582 | 48"x 38" | 240 56617 |
| 32"x 24" | 112 56462 | 36"x 18" | 96 56490 | 40"x 04" | 40 56518 | 42"x 20" | 120 56545 | 46"x 14" | 96 56583 | 48"x 40" | 252 56618 |
| 32"x 26" | 120 56463 | 36"x 20" | 104 56491 | 40"x 06" | 52 56519 | 42"x 22" | 128 56546 | 46"x 16" | 108 56584 | 48"x 42" | 260 56619 |
| 32"x 28" | 124 56464 | 36"x 22" | 104 56492 | 40"x 08" | 60 56520 | 42"x 24" | 140 56547 | 46"x 18" | 120 56585 | 48"x 44" | 272 56620 |
| 32"x 32" | 140 56466 | 36"x 24" | 120 56493 | 40"x 10" | 68 56521 | 42"x 26" | 148 56548 | 46"x 20" | 128 56586 | 48"x 48" | 296 56622 |
| 34"x 04" | 36 56467 | 36"x 26" | 132 56494 | 40"x 12" | 80 56522 | 42"x 28" | 156 564549 | 46"x 22" NSH | 140 56587 | - | - |
| 34"x 06" | 44 56468 | 36"x 28" | 140 56495 | 40"x 14" | 88 56523 | 42"x 30" | 168 56550 | 46"x 24" | 148 56588 | - | - |
| 34"x 08" | 52 56469 | 36"x 30" | 148 56496 | 40"x 16" | 96 56524 | 42"x 32" | 176 56551 | 46"x 26" | 160 56589 | - | - |
| 34"x 10" | 60 56470 | 36"x 32" | 156 56497 | 40"x 18" | 104 56525 | 42"x 34" | 188 56552 | 46"x 28" | 172 56590 | - | - |

Fixed Bar Return Grille – Lay-in



FBH3S / FBH3A

Aluminum grille • Steel or Aluminum

Features:

- 24"x 24" Lay-in filler panel design
- Fixed blades on 5/8" spacing
- Sight tight design
- 45° deflection
- Aluminum version is MRI compatible – no ferrous parts
- Fits OBDB damper
- White powder coated epoxy finish



FBH3S/FBH3A

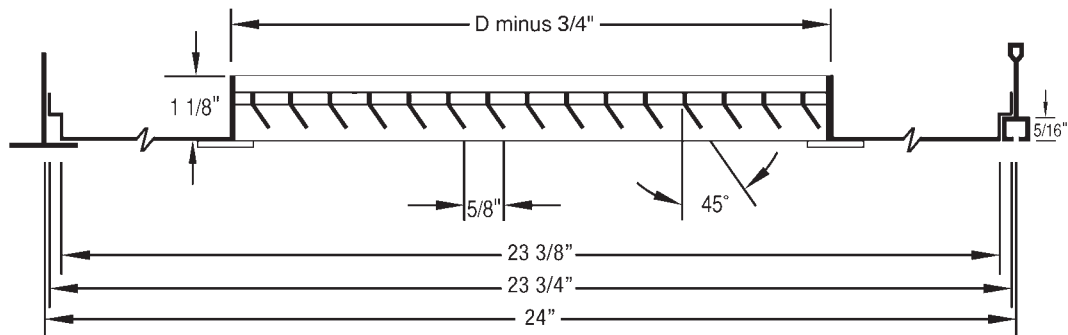

Exclusive ADP Feature!
Universal frame design fits both
Standard and Narrow-Tee Grids!

| Duct Size | Steel FBH3S | Aluminum FBH3A |
|-----------|---------------------|----------------|
| | List Price | List Price |
| | SKU | SKU |
| 06"x 06" | 74 52125 | • |
| 08"x 08" | 83 52126 | • |
| 10"x 10" | 87 52127 | • |
| 12"x 12" | 87 52128 | • |
| 14"x 14" | 100 52129 | • |
| 16"x 16" | 109 52130 | • |
| 18"x 18" | 122 52131 | • |
| 20"x 20" | 131 52132 | • |

• White dots = Low demand items.
 Check availability before quoting.

Note: Please call for Aluminum panel price and sku.

Related items

Hard Ceiling Frames – Page 36
 Accessory Dampers – Pages 39, 40
 Neck Adapters – Pages 41, 42

FBHF1 (Bar type)

Steel or Aluminum • Horizontal blades

Features:

- Matches FBH1 in appearance
- 35° fixed blades on 3/4" centers
- Top hinge with quarter turn fastener
- Accommodates 1" filter
- White powder coated finish



FBHF1

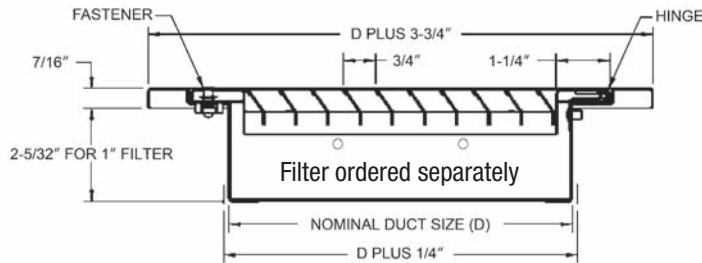

| Panel Size | Filter Size | List Price FBHF1S Steel SKU | List Price FBHF1A Aluminum SKU | Add for MERV 8 Filter SKU |
|------------|----------------|--------------------------------|-----------------------------------|------------------------------|
| 24" x 12" | 20" x 8" x 1" | 150 51819 | • | 22 12637 |
| 24" x 24" | 20" x 20" x 1" | 170 51178 | • | 18 11415 |
| 48" x 24" | 44" x 20" x 1" | 370 51179 | • | 44 12636 |

• White dots = Low demand items. Check availability before quoting.

Lay-in Filter Grilles

ECF1 (Egg Crate type)

Aluminum grid • Aluminum border

Features:

- Matches EC1A in appearance
- 1/2" x 1/2" x 1/2" aluminum grid core
- 90% free area for minimal pressure drop
- Top hinge with quarter turn fastener
- Accommodates 1" filter
- White powder coated finish

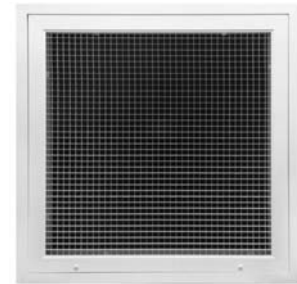

ECF1

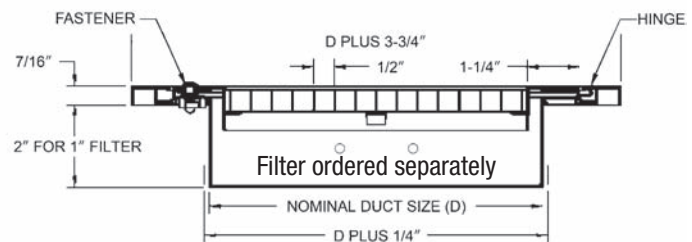

| Panel Size | Filter Size | List Price ECF1A Aluminum SKU | Add for MERV 8 Filter SKU |
|------------|----------------|----------------------------------|------------------------------|
| 24" x 12" | 20" x 8" x 1" | 180 51818 | 22 12637 |
| 24" x 24" | 20" x 20" x 1" | 240 51794 | 18 11415 |
| 48" x 24" | 44" x 20" x 1" | 580 51795 | 44 12636 |

• White dots = Low demand items. Check availability before quoting.

Egg Crate Return Grille – Surface Mount



EC1A

Aluminum grid • Aluminum frame

Features:

- 1/2" x 1/2" x 1/2" aluminum grid core
- 90% free area for minimal pressure drop
- Fits OBDB Damper
- MRI compatible – no ferrous parts
- White powder coated epoxy finish



EC1A

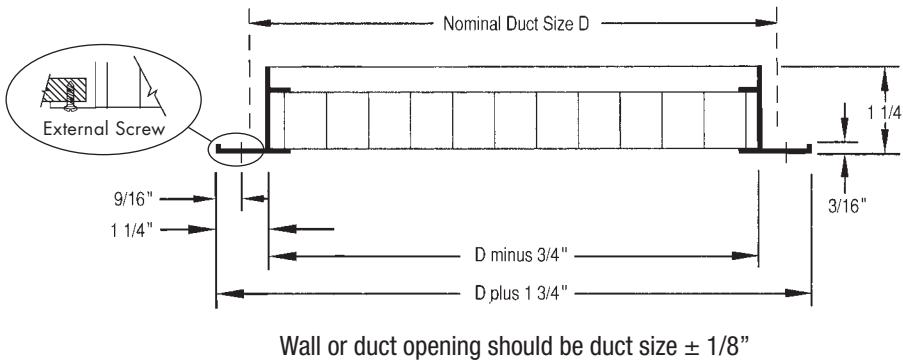

| Duct Size | List Price SKU |
|-----------|-------------------|
| 6"x6" | 20 56321 |
| 8"x8" | 26 56322 |
| 10"x10" | 30 56323 |
| 12"x12" | 34 56324 |
| 14"x14" | 44 56325 |
| 16"x16" | 50 56326 |

| Duct Size | List Price SKU |
|-----------|-------------------|
| 18"x18" | 58 56327 |
| 20"x20" | 68 56328 |
| 22"x22"* | 76 56330 |
| 24"x24" | 88 56331 |
| 22"x10"* | 46 56329 |
| 46"x22"* | 166 56332 |

Egg Crate Return Grille – Lay-in

*Stocked without screw holes for Lay-in T-Bar ceilings.

EC3S (Ducted)

Aluminum grid • Steel Lay-in panel

Features:

- 24" x 24" Lay-in filler panel
- 1/2" x 1/2" x 1/2" aluminum grid core
- 90% free area for minimal pressure drop
- White powder coated epoxy finish

Exclusive ADP Feature!
Universal frame design fits both
Standard and Narrow-Tee Grids!



EC3S

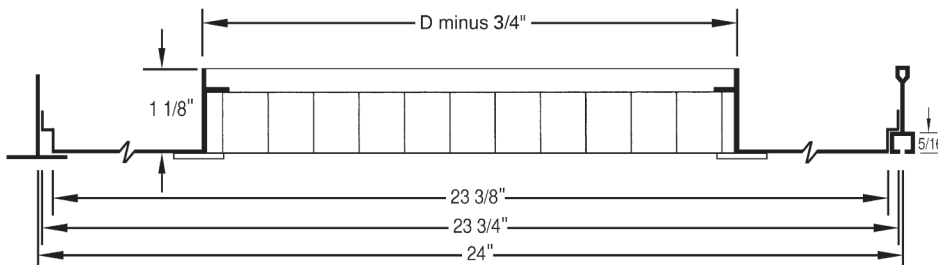

| Duct Size | EC3S | |
|-----------|------------|-------|
| | List Price | SKU |
| 6"x6" | 88 | 52117 |
| 8"x8" | 96 | 52118 |
| 10"x10" | 100 | 52119 |
| 12"x12" | 106 | 52120 |
| 14"x14" | 122 | 52121 |
| 16"x16" | 128 | 52122 |
| 18"x18" | 144 | 52123 |
| 20"x20" | 156 | 52124 |

Related items

Hard Ceiling Frames – Page 36
Accessory Dampers – Pages 39, 40
Neck Adapters – Pages 41, 42

Note: An all aluminum MRI compatible EC3A version will be available soon – please call for pricing and sku.

ECX (Non-ducted)

Aluminum or plastic grid • Unframed

Features:

- 90% free area
- Unframed 1/2" x 1/2" x 1/2" grid
- Aluminum or plastic (Styrene)

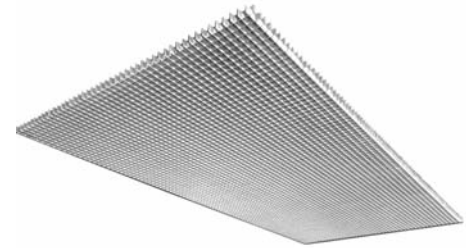
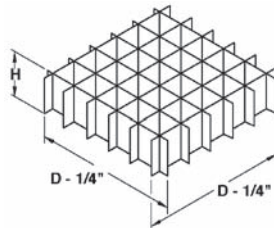

ECXA / ECXW / ECXP

| Model | Material | Finish | 24" x 12" | SKU | 24" x 24" | SKU | 48" x 24" | SKU |
|-------|-------------|--------|-----------|-------|-----------|-------|-----------|-------|
| ECXA | Aluminum | Mill | 40 • | 56930 | 60 | 56929 | 80 | 56345 |
| ECXW | Aluminum | White | 50 • | 56933 | 75 | 56932 | 100 | 56931 |
| ECXP | Polystyrene | White | 20 • | 52429 | 30 • | 52430 | 40 • | 52426 |

• White dots = Low demand items. Check availability before quoting.

Hard Lid Frame Adapter

HLFA

Features:

- Allows installation of any lay-in diffuser or grille in hard or plaster ceiling
- Easy screw/clip installation
- Recommended ceiling opening is module size plus 1/2"
- Extruded Aluminum with white powder coated epoxy finish

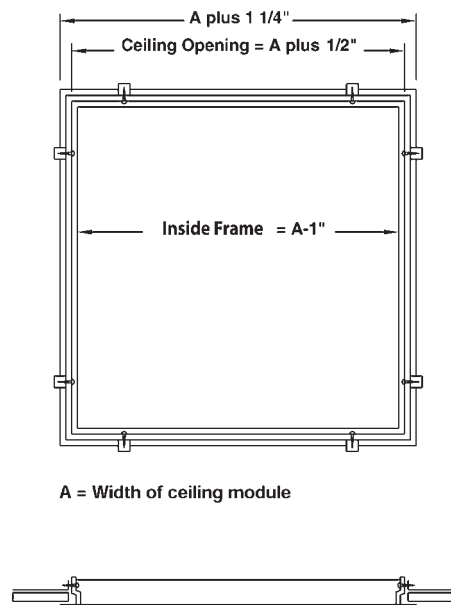
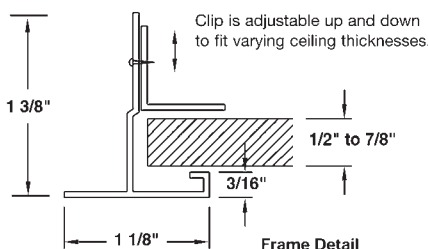

HLFA

| Ceiling Module Size | List Price HLFA SKU |
|---------------------|------------------------|
| 12" x 12" | 48 52418 |
| 24" x 12" | 50 52417 |
| 24" x 24" | 56 52416 |
| 48" x 24" | 112 • 52422 |

• White dots = Low demand items. Check availability before quoting.

Touch-up Paint

TUP

Appliance white & flat black paint to match ADP grilles, registers, & diffusers

| Model | Color | List Price SKU |
|-------|------------|-------------------|
| TUPW | ADP White | 18 12301 |
| TUPB | Flat Black | 13 12300 |



ADP White



Flat Black

Drop Down Diffuser



DR4040

Steel • Adjustable louvers

Features:

- Evaporative cooler diffuser
- Drop box design
- Large airflow capacity
- Heavy 22 gauge steel frame construction with white powder coated epoxy finish



DR4040

Dimensions (in inches)

| Duct Size D | A Square | B | Max CFM @ 700 FPM | DR4040 List Price | SKU |
|-------------|----------|---|-------------------|-------------------|-------|
| 14" x 14" | 15 3/4 | 5 | 856 | 84 | 52109 |
| 16" x 16" | 17 3/4 | 5 | 1008 | 92 | 52110 |
| 18" x 18" | 19 3/4 | 5 | 1183 | 100 | 52111 |
| 20" x 20" | 21 3/4 | 6 | 1484 | 128 | 52112 |
| 22" x 22"* | 23 3/4* | 6 | 1659 | 152 | 52113 |
| 24" x 24" | 25 3/4 | 6 | 1834 | 192 | 52114 |
| 30" x 30" | 31 3/4 | 6 | 2296 | 328 | 52115 |
| 32" x 32" | 33 3/4 | 8 | 2471 | 412 | 52116 |

White dots = Low demand items. Check availability before quoting.

* Size 22" x 22" also fits Lay-in ceiling grids

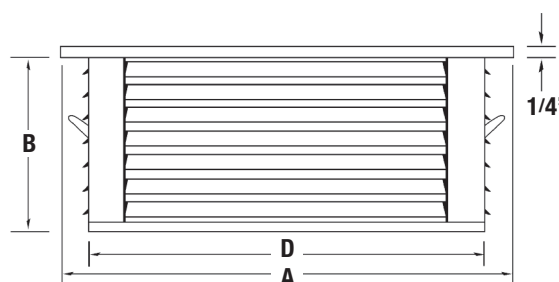

Retrofit Draft Eliminator

CAF Control-A-Flow®

Features:

- Draft eliminator with anti-microbial filter
- Attaches to lay-in ceiling grid and fits over diffuser face
- Traps and kills 86.5% of all airborne micro-organisms on contact
- Converts occupant complaints into silence and comfort
- Eliminates dusty, dirty ceilings
- Preserves air volume and maintains system air balance
- Prevents ash from entering occupied space during fire season



Control-A-Flow

| Model | Description | List Price | SKU |
|-------|---|------------|-------|
| CFTB | Control-A-Flow® kit with filter for T-bar ceiling | 240 | 11323 |
| CFRF | Control-A-Flow® replacement filter | 60 | 11322 |

IAQ 1000

Steel • Adjustable louvers



IAQ 1000

Features:

- 4-Way adjustable flow pattern
- Fits most lay-in perforated diffuser backpans
- Attractive, office-friendly appearance
- Reduces energy costs
- Eliminates cold air drafts
- 0.3 micron electrostatic filter
- MERV Rating 13-14
- Six month average filter life
- Hinges open for easy filter replacement
- Improves Indoor Air Quality by capturing airborne contaminants before they enter room
- Prevents ash from entering occupied space during fire season
- Steel construction, white powder coated epoxy finish

This product may qualify for up to **3 LEED** points:

- One for energy savings
- One for IAQ
- One for indoor comfort

| Model | Description | List Price | SKU |
|-----------------|---|------------|-------|
| IAQ 1000 | 4-Way discharge filtered diffuser face (24" x 24")* | 180 | 52133 |
| IAQ 1000 FILTER | Replacement filters (set of 4) | 48 | 52134 |
| IAQ 1000 PAN 6 | 6" neck steel backpan (for new installations) | 60 | 52135 |
| IAQ 1000 PAN 8 | 8" neck steel backpan (for new installations) | 60 | 52136 |
| IAQ 1000 PAN 10 | 10" neck steel backpan (for new installations) | 60 | 52137 |
| IAQ 1000 PAN 12 | 12" neck steel backpan (for new installations) | 60 | 52138 |
| IAQ 1000 PAN 14 | 14" neck steel backpan (for new installations) | 60 | 52139 |

* Retrofits to existing lay-in perforated diffuser backpan



IAQ 1000



Aesthetically pleasing, streamlined and low profile!
Only 1-3/4" inches below ceiling.

Easily-replaced electrostatic filter, no power required.



OBDB / OBDBS / OBDBL

Opposed Blade Dampers for Square and Rectangular Necks

OBDB: Fits D minus 3/4" necks (use for all models except those listed below)

OBDBS: Fits D minus 1/4" or 1/2" necks (use for AM3, AM5, AM6, APC3, APC5, APM1, APM3, APM5, APS3 & APA3 diffusers)

OBDBL: Fits D minus 1/4" necks (use for AL1, AL3 & AL6 diffusers – lever operated)



OBDB/OBDBS
(screwdriver operated)

Features:

- Heavy-gauge steel construction
- Gang-operated opposed blades meter air volume precisely with minimum air disturbance
- Flat black powder coated epoxy finish

Exclusive ADP Feature!

INDUSTRY'S BEST OBD

- Flat black eliminates reflection
- Heavy-duty construction
- Smooth, non-binding operation
- Attached with electro-plated Z-clips that never rust
- Ten-Year Free Replacement Warranty!

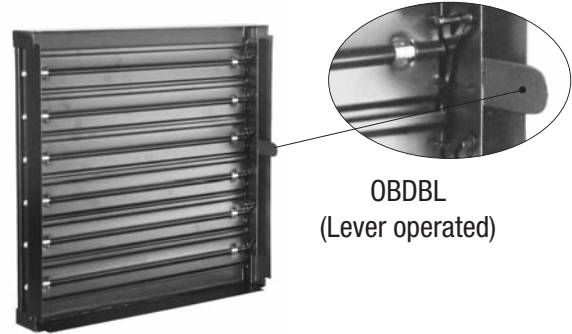

OBDBL
(Lever operated)

| Duct Size | List Price OBDB |
|-----------|-----------------|
| | SKU |
| 6"x4" | 12 56753 |
| 6"x6" | 12 56754 |
| 8"x4" | 12 56755 |
| 8"x6" | 12 56756 |
| 8"x8" | 16 56757 |
| 9"x9" | 16 56758 |
| 10"x4" | 12 56759 |
| 10"x6" | 16 56760 |
| 10"x8" | 16 56761 |
| 10"x10" | 16 56762 |
| 12"x4" | 16 56763 |
| 12"x6" | 16 56764 |
| 12"x8" | 16 56765 |
| 12"x10" | 20 56766 |

| Duct Size | List Price OBDB |
|-----------|-----------------|
| | SKU |
| 12"x12" | 20 56767 |
| 14" x 4" | 16 56768 |
| 14"x6" | 16 56769 |
| 14"x8" | 20 56770 |
| 14"x10" | 20 56771 |
| 14"x12" | 20 56772 |
| 14"x14" | 24 56773 |
| 16"x4" | 16 56775 |
| 16"x6" | 20 56776 |
| 16"x8" | 20 56777 |
| 16"x10" | 20 56778 |
| 16"x12" | 24 56779 |
| 16"x14" | 24 56780 |
| 16"x16" | 28 56781 |

| Duct Size | List Price OBDB |
|-----------|-----------------|
| | SKU |
| 18"x4" | 20 56782 |
| 18"x6" | 20 56783 |
| 18"x8" | 20 56784 |
| 18"x10" | 24 56785 |
| 18"x12" | 24 56786 |
| 18"x14" | 28 56787 |
| 18"x16" | 28 56788 |
| 18"x18" | 32 56789 |
| 20"x4" | 20 56790 |
| 20"x6" | 20 56791 |
| 20"x8" | 24 56792 |
| 20"x10" | 24 56793 |
| 20"x12" | 28 56794 |
| 20"x14" | 28 56795 |

| Duct Size | List Price OBDB |
|-----------|-----------------|
| | SKU |
| 20"x16" | 32 56796 |
| 20"x18" | 32 56797 |
| 20"x20" | 36 56798 |
| 22"x10" | 28 56802 |
| 22"x22" | 40 56807 |
| 24" x 4" | 20 56808 |
| 24" x 6" | 24 56809 |
| 24" x 8" | 28 56810 |
| 24" x 10" | 28 56811 |
| 24" x 12" | 32 56812 |
| 24" x 14" | 32 56813 |
| 24" x 16" | 36 56814 |
| 24" x 18" | 36 56815 |
| 24" x 24" | 64 56934 |

| Duct Size | List Price OBDBS | List Price OBDBL |
|-----------|------------------|------------------|
| | SKU | SKU |
| 6"x6" | 12 56893 | 12 56820 |
| 8"x8" | 16 56894 | - |
| 9"x9" | - | 18 56878 |
| 10"x10" | 16 56895 | - |
| 12"x12" | 20 56896 | 20 56879 |
| 14"x14" | 24 56897 | - |
| 15"x15" | - | 36 56880 |
| 16"x16" | 28 56898 | - |
| 18"x18" | 32 56899 | 52 56881 |
| 20"x20" | 36 56900 | - |
| 21"x21" | - | 64 56882 |
| 22"x22" | 40 Ask | - |
| 24"x24" | 60 56901 | 68 56883 |

BBD1 / BBD2 / SBD

Radial Blade Dampers for Round Necks

BBD1

Opposed Blade Damper – Duct Mounted

Gang-operated opposed blades (three sets on sizes 6” through 12”, four sets on 14” through 20”) distribute air evenly through the diffuser. For use in round duct applications. Not recommended for flexible duct applications. Material is galvanized steel.

| Duct Size | List Price SKU |
|-----------|-------------------|
| 6” | 36 51255 |
| 8” | 36 51256 |
| 10” | 38 51257 |
| 12” | 40 51258 |
| 14” | 52 51259 |
| 15” | 54 51260 |
| 16” | 56 51261 |
| 18” | 58 51262 |
| 20” | 65 51263 |
| 24” | 80 51264 |

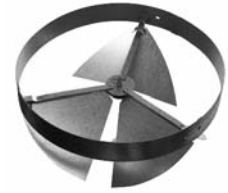

Sizes 6” to 12”
Galvanized steel construction



Sizes 14” to 24”
Steel construction
flat black painted finish

BBD2

Opposed Blade Damper – Neck Mounted

Mounts flush with the top of the diffuser neck. Especially useful in flex duct, or where height is restricted. Three sets of gang-operated opposed blades distribute air evenly through the diffuser. Quickly and easily adjusted from the face side of the diffuser. Material is galvanized steel.

| Duct Size | List Price SKU |
|-----------|-------------------|
| 6” | 34 51291 |
| 8” | 34 51292 |
| 10” | 36 51293 |
| 12” | 36 51294 |



Sizes 6” to 12”
Galvanized steel construction

SBD

Sliding Blade Damper – Neck Mounted

Gang-operated radial blades slide, each blade over the next, at right angles to the air flow. Mounts directly on the diffuser neck, flush with the top. Useful in flex duct or where height is limited. Material is galvanized steel.

| Duct Size | List Price SKU |
|-----------|-------------------|
| 6” | 24 51286 |
| 8” | 26 51287 |
| 10” | 26 51288 |
| 12” | 28 51289 |
| 14” | 44 51290 |

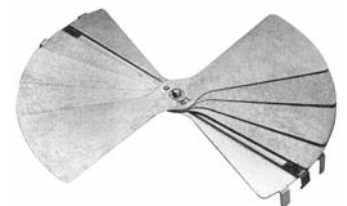

Sizes 6” to 14”
Galvanized steel construction

STR / STRF

Features:

- Heavy 24 gauge galvanized steel construction
- 2.5" collar with raised bead
- Interior painted flat black
- Ceiling box is prefabricated with flanges



STR
Round Neck
Adapters

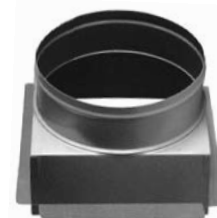

STRF
Ceiling Box

| STR Size | Gauge | Diameter | | | | | | | | | | | |
|--------------|-------|--|-------------|-------------|-------------|-------------|-------------|-------------|-------------|-------------|-------------|-------------|--------------|
| | | 04" SKU | 05" SKU | 06" SKU | 07" SKU | 08" SKU | 09" SKU | 10" SKU | 12" SKU | 14" SKU | 16" SKU | 18" SKU | 20" SKU |
| 6"x 6" | 24 | 22 55219 | 22 55220 | 22 55221 | - | - | - | - | - | - | - | - | - |
| 8"x 8" | 24 | - | - | 25 55222 | 25 55223 | 25 55224 | - | - | - | - | - | - | - |
| 9"x 9" | 24 | - | - | 28 55225 | 28 55226 | 28 55227 | 28 55228 | - | - | - | - | - | - |
| 10"x 10" | 24 | - | - | 28 55229 | 28 55230 | 28 55231 | 28 55232 | 28 55233 | - | - | - | - | - |
| 12"x 12" | 24 | - | - | 30 55234 | 30 55235 | 30 55236 | 30 55237 | 30 55238 | 30 55239 | - | - | - | - |
| 14"x 14" | 24 | - | - | - | - | 35 55240 | 35 55241 | 35 55242 | 35 55243 | 35 55244 | - | - | - |
| 15"x 15" | 24 | - | - | - | - | 38 55245 | - | 38 55247 | 38 55248 | 38 55249 | - | - | - |
| 16"x 16" | 24 | - | - | - | - | 38 55250 | - | 38 55251 | 38 55252 | 38 55253 | 38 55254 | - | - |
| 18"x 18" | 24 | - | - | - | - | 50 55255 | - | 50 55256 | 50 55257 | 50 55258 | 50 55259 | 50 55260 | - |
| 20"x 20" | 24 | - | - | - | - | 56 55261 | - | 56 55262 | 56 55263 | 56 55264 | 56 55265 | 56 55266 | 56 55267 |
| 22"x 22" | 24 | - | - | 60 55273 | - | 60 55274 | 60 55275 | 60 55276 | 60 55277 | 60 55278 | 60 55279 | 60 55280 | 60 55281 |
| 23.5"x 23.5" | 24 | - | - | 78 55286 | - | - | - | - | - | - | - | - | - |
| 22"x 10" | 24 | - | - | 50 55268 | - | 50 55270 | - | 50 55271 | 50 55272 | - | - | - | - |
| 23.5"x 11.5" | 24 | - | - | 58 55282 | - | 58 55283 | - | 58 55284 | 58 55285 | - | - | - | - |
| 46" x 22" | 24 | (Square pan only – hole is field cut – unpainted galvanized steel) | | | | | | | | | | | 130 55199 |

| STRF Size | Gauge | Diameter | | | | | | | | | | | |
|-----------|-------|------------|-------------|-------------|-------------|-------------|-------------|-------------|-------------|-------------|-------------|-------------|------------|
| | | 04" SKU | 05" SKU | 06" SKU | 07" SKU | 08" SKU | 09" SKU | 10" SKU | 12" SKU | 14" SKU | 16" SKU | 18" SKU | 20" SKU |
| 6"x 6" | 24 | - | 24 55294 | 24 55295 | - | - | - | - | - | - | - | - | - |
| 8"x 8" | 24 | - | 28 55296 | 28 55297 | 28 55298 | 28 55299 | - | - | - | - | - | - | - |
| 10"x 10" | 24 | - | - | 32 55300 | 32 55301 | 32 55302 | 32 55303 | 32 55304 | - | - | - | - | - |
| 12"x 12" | 24 | - | - | - | 34 55305 | 34 55306 | 34 55307 | 34 55308 | 34 55309 | - | - | - | - |
| 14"x 14" | 24 | - | - | - | - | - | - | 40 55319 | 40 55310 | 40 55311 | - | - | - |
| 16"x 16" | 24 | - | - | - | - | - | - | 42 55312 | 42 55313 | 42 55320 | 42 55314 | - | - |
| 18"x 18" | 24 | - | - | - | - | - | - | - | 55 55315 | 55 55316 | 55 55317 | 55 55318 | - |

RTR

Features:

- Heavy 24 gauge galvanized steel construction
- 2.5" collar with raised bead
- Interior painted flat black

RTR
Pancake Reducer



| RTR Size | Gauge | List Price | SKU |
|----------|-------|------------|-------|
| 6" x 4" | 24 | 19 | 55200 |
| 6" x 5" | 24 | 19 | 55201 |
| 8" x 6" | 24 | 22 | 55202 |
| 8" x 7" | 24 | 22 | 55203 |
| 10" x 6" | 24 | 24 | 55204 |
| 10" x 7" | 24 | 24 | 55205 |
| 10" x 8" | 24 | 24 | 55206 |
| 10" x 9" | 24 | 24 | 55207 |
| 12" x 6" | 24 | 36 | 55208 |
| 12" x 7" | 24 | 36 | 55209 |

| RTR Size | Gauge | List Price | SKU |
|-----------|-------|------------|-------|
| 12" x 8" | 24 | 36 | 55210 |
| 12" x 9" | 24 | 36 | 55211 |
| 12" x 10" | 24 | 36 | 55212 |
| 14" x 10" | 24 | 41 | 55213 |
| 14" x 12" | 24 | 41 | 55214 |
| 16" x 12" | 24 | 48 | 55215 |
| 16" x 14" | 24 | 48 | 55216 |
| 18" x 14" | 24 | 50 | 55217 |
| 18" x 16" | 24 | 50 | 55218 |

Taper Reducers

TRC / TRSF / TRD

Features:

- Fabricated or drawn steel
- Material: Galvanized steel



TRSF
Sure Fit
Tapers



TRC
Conical Taper 8"
High



TRD
Drawn Steel
Reducer

TRSF TAPERS

| Size | Gauge | List Price | SKU |
|-----------|-------|------------|-------|
| 8" x 6" | 26 | 20 | 71304 |
| 10" x 8" | 26 | 22 | 71305 |
| 12" x 10" | 26 | 26 | 71306 |
| 14" x 12" | 24 | 36 | 71307 |
| 16" x 14" | 24 | 54 | 71308 |

TRC TAPERS

| Size | Gauge | List Price | SKU |
|-----------|-------|------------|-------|
| 6" x 5" | 26 | 12 | 71309 |
| 8" x 6" | 26 | 16 | 71310 |
| 8" x 7" | 26 | 16 | 71311 |
| 9" x 8" | 26 | 19 | 71312 |
| 10" x 6" | 26 | 22 | 71313 |
| 10" x 7" | 26 | 22 | 71314 |
| 10" x 8" | 26 | 22 | 71315 |
| 10" x 9" | 26 | 22 | 71316 |
| 12" x 8" | 26 | 24 | 71317 |
| 12" x 9" | 26 | 24 | 71318 |
| 12" x 10" | 26 | 24 | 71319 |
| 14" x 10" | 24 | 30 | 71320 |
| 14" x 12" | 24 | 30 | 71321 |
| 16" x 12" | 24 | 36 | 71322 |
| 16" x 14" | 24 | 36 | 71323 |
| 16" x 15" | 24 | 36 | 71324 |

TRD TAPERS

| Size | Gauge | List Price | SKU |
|---------|-------|------------|-------|
| 6" x 4" | 20 | 18 | 61154 |
| 6" x 5" | 20 | 18 | 61155 |

| Model | Page | Model | Page |
|--------------|-------------|----------------|-------------|
| AAB..... | 1 | CB | 26 |
| AABP | 2 | CFRF..... | 39 |
| ABP ID | 2 | CFTB..... | 39 |
| AC3..... | 19 | DDVA | 29,30 |
| AL1 | 23 | DR4040 | 37 |
| AL3..... | 24 | EC1A..... | 35 |
| AL6..... | 23 | EC3S..... | 35 |
| ALXA..... | 25 | ECF1 | 34 |
| ALS..... | 3 | ECXA..... | 36 |
| ALSP | 4 | ECXW..... | 36 |
| ALSP ID..... | 4 | ECXP..... | 36 |
| AM3..... | 22 | FBH1A | 31,32 |
| AM5..... | 21 | FBH3S | 33 |
| AM6..... | 21 | FBHF1 | 34 |
| A03 | 20 | HLFA..... | 36 |
| APA3..... | 9 | IAQ 1000 | 38 |
| APC3 | 5,6 | OBDB..... | 39 |
| APC5 | 15 | OBDBL..... | 39 |
| APDB | 14 | OBDBS..... | 39 |
| APM1 | 15 | RTR..... | 42 |
| APM3..... | 7,8 | SBD | 40 |
| APM4..... | 17 | SCG | 14 |
| APM5..... | 15 | STR..... | 41 |
| APMF | 14 | STRF | 41 |
| APR1 | 16 | TRC | 42 |
| APR3..... | 11,12 | TRD | 42 |
| APR4 | 18 | TRSF..... | 42 |
| APR5 | 16 | TUPB | 36 |
| APS3..... | 10 | TUPW..... | 36 |
| APX3..... | 13 | | |
| AR2..... | 27 | | |
| AR3..... | 28 | | |
| BBD1 | 40 | | |
| BBD2 | 40 | | |

Exclusive ADP Feature!
Same Day, Next Day and Standard 2-Day shipping options on everything above!

Depend on ADP for features that make a difference!



Universal Lay-in Frames

LAY-IN DIFFUSERS

Our exclusive Universal Frame design allows our AC, AO & AM diffusers to be installed in Standard T-Bar ceilings as well as Narrow-Tee (Donn Fineline) grids. Our complimenting EC3 and FBH3 lay-in returns feature this same exclusive design.

- No premium or wait for special frames
- No need to double stock
- No jobsite sorting or installation errors
- One ingenious design fits all

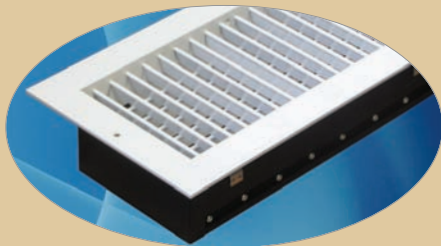

Aluminum registers with black OBDs

SUPPLY & RETURN REGISTERS

Our commercial registers are the best value in the business. Priced competitively with steel equivalents, our aluminum grilles feature heavy extruded aluminum construction with a durable powder coated finish, and our DDVA registers are securely attached to a sturdy steel damper with a flat-black powder coated finish.

- No rust on the room side
- No reflection from the duct side
- No complaints from the end user
- Free Blade Adjustment Tool with every order speeds field installation and adjustment



Blade Adjustment Tool

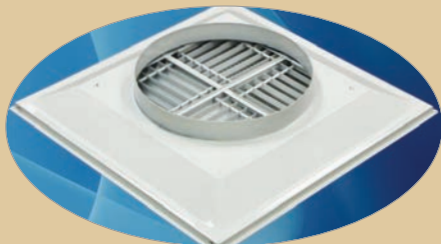

Integral round necks

PERFORATED MOD-CORE DIFFUSERS

ADP introduced the extremely popular MAC Series modular core diffuser over five decades ago, and we continually refine and improve our invention. Our perforated version of this diffuser, the APM3, is the only diffuser of its type available with an integral round collar at no increase in price over the square neck version.

- Low profile design conserves ceiling space
- No need for separate and expensive round adapters
- Integral round neck saves up to \$50 per diffuser in purchasing, handling and installation costs

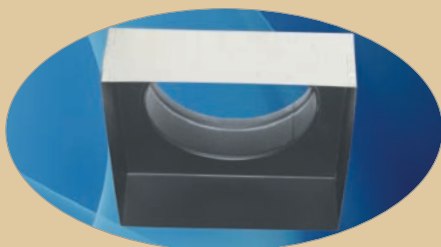

Adapters with black interiors

SQUARE-TO-ROUND ADAPTERS

Ours have features you rarely see. With interiors painted flat-black, full 2-1/2" beaded collars, and heavy 24 gauge construction, installers love our cans.

- No reflection back through the grille or diffuser
- No need to paint at jobsite
- Faster and more secure flex duct attachment
- No sharp edges, no gloves required
- Less damage in shipment and handling



OBDBs guaranteed for ten years

OBDB DAMPERS

Compare our standard OBDB damper to the light-weight galvanized dampers used by the competition. There is no comparison. With flat-black powder coated standard finish, heavy duty construction, smooth non-binding linkage, sturdy manganese plated Z-clips, and a ten year free replacement guarantee, there is no better OBD in the business.

- No shiny metal reflections
- No field painting needed
- Won't rack, rattle or bind
- Heavier gauges and painted edges reduce field cuts and injuries
- Ten year free replacement guarantee

All this ships in **2 Days** or less! Who knew?

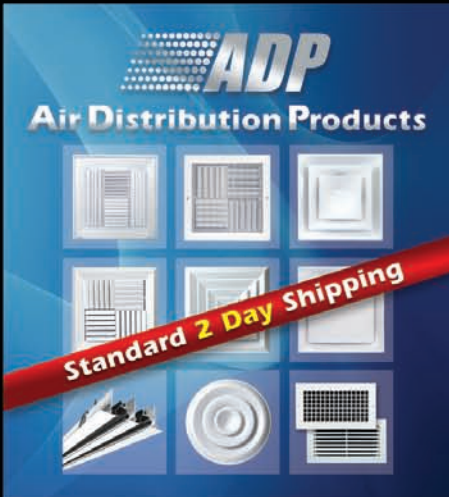

ADP
Air Distribution Products

Standard 2 Day Shipping

A 3x3 grid of nine different air distribution products, including various styles of diffusers and registers.



ADP
Air Device Products

Standard 2 Day Shipping

A 3x3 grid of nine air device products, including coils, filters, and other HVAC components.

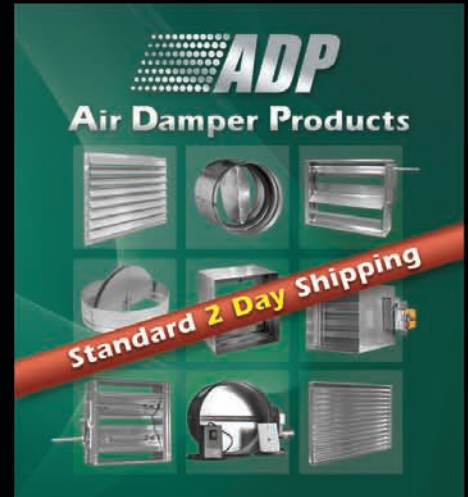

ADP
Air Damper Products

Standard 2 Day Shipping

A 3x3 grid of nine air damper products, including various types of dampers and valves.



ADP
Air Delivery Products

Standard 2 Day Shipping

A 3x3 grid of nine air delivery products, including various types of air delivery devices and components.



ADP
Access Door Products

Standard 2 Day Shipping

A 3x3 grid of nine access door products, including various styles of doors and covers.



ADP
Air Duct Products

Standard 2 Day Shipping

A 3x3 grid of nine air duct products, including various types of ducts and fittings.



Serving the HVAC Industry Since 1952

Ph 800.322.8676 • www.adp-hvac.com • Fx 800.604.3324

9668-D Heinrich Hertz Drive, San Diego, CA 92154